

Technical drawing

5 x  Easy set up: 45 minutes

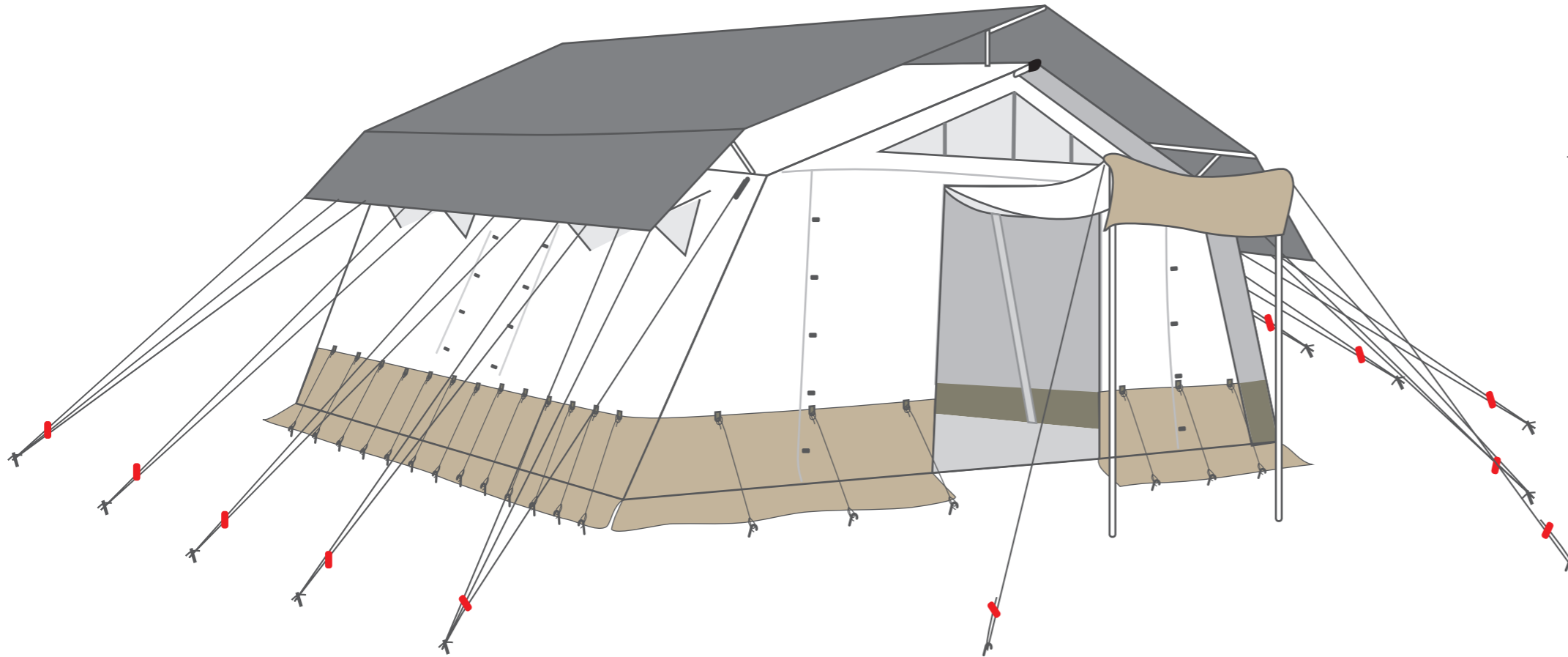

General view

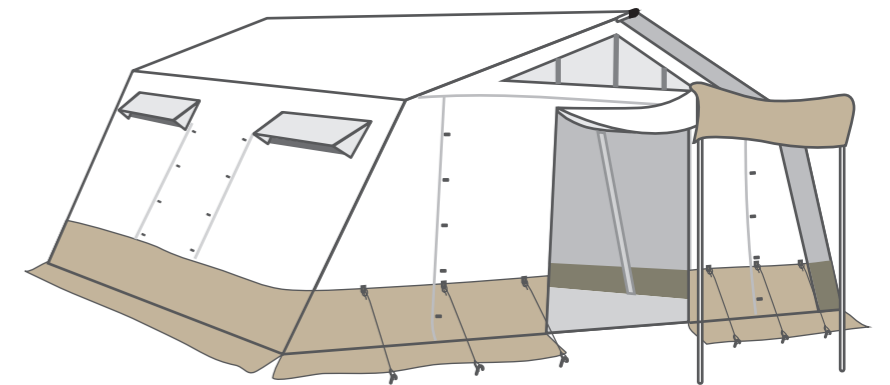



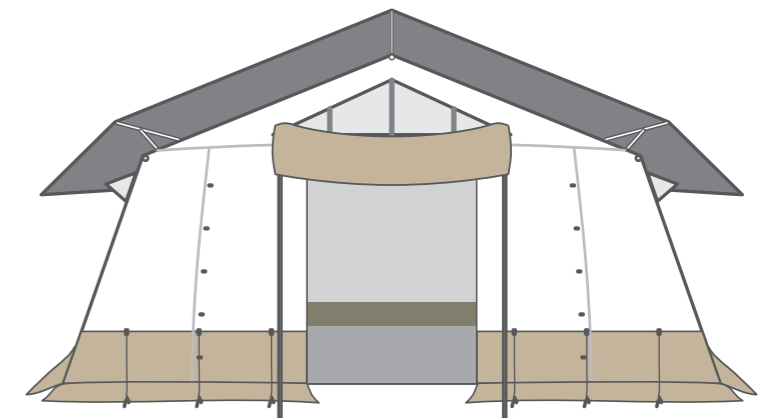



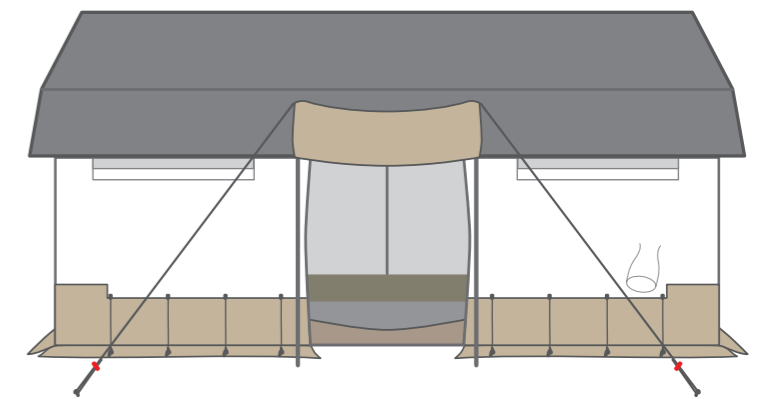







Front view



Side view



Packing list

A	22x	Tent poles		14x	Tent pegs	
B	6x	Pipes		1x	Hammer	
C	15x	Frame joints		1x	Flysheet	
D	10x	Standing poles		1x	Inner	
E	4x	Canopy supporting poles		1x	Ground sheet	
F	3x	Shade net frames		1x	Shade net	
	44x	Twisted rod pegs		1x	Partition (optional)	
	32x	Steel pins				

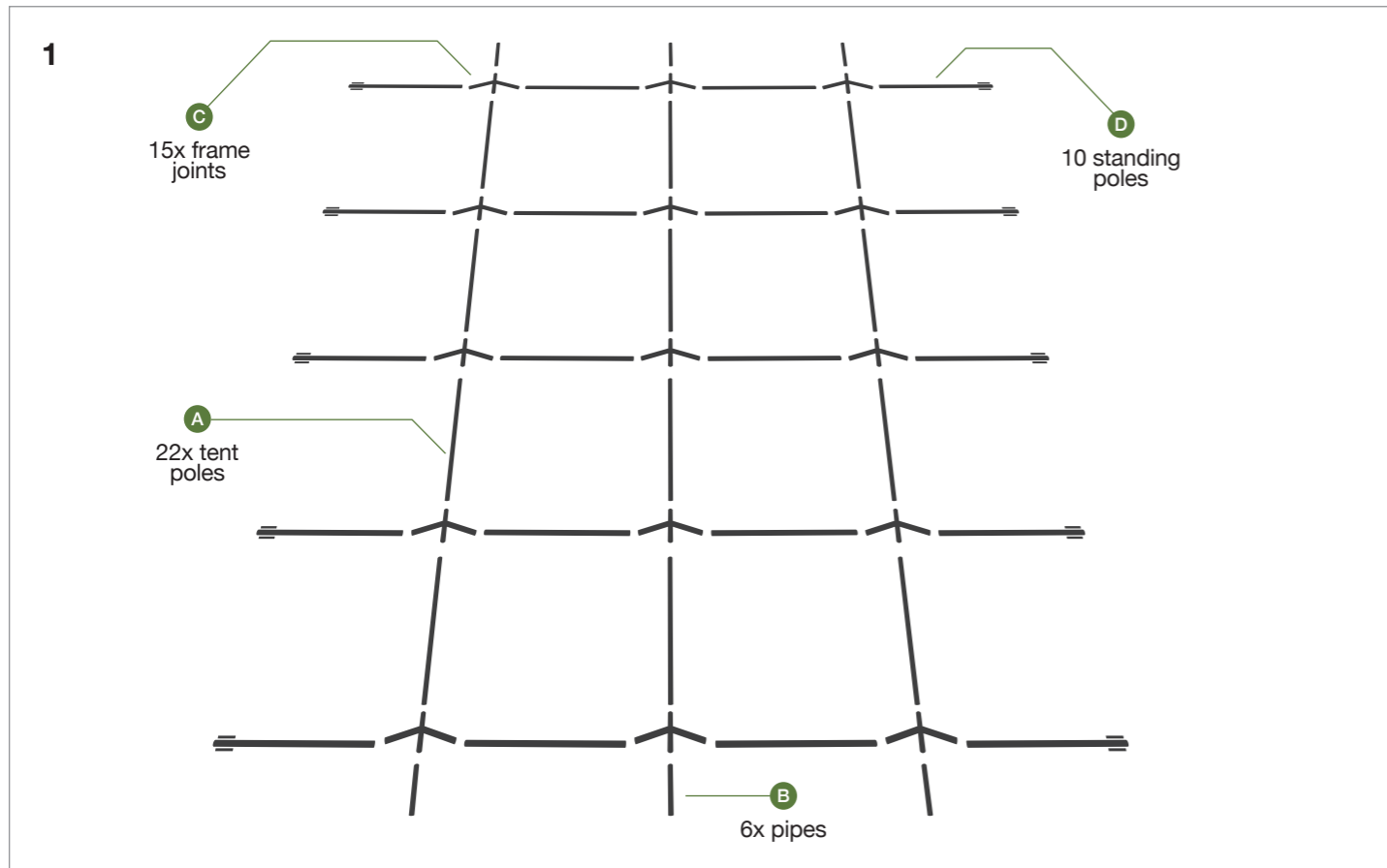

Layout all the poles and joints.

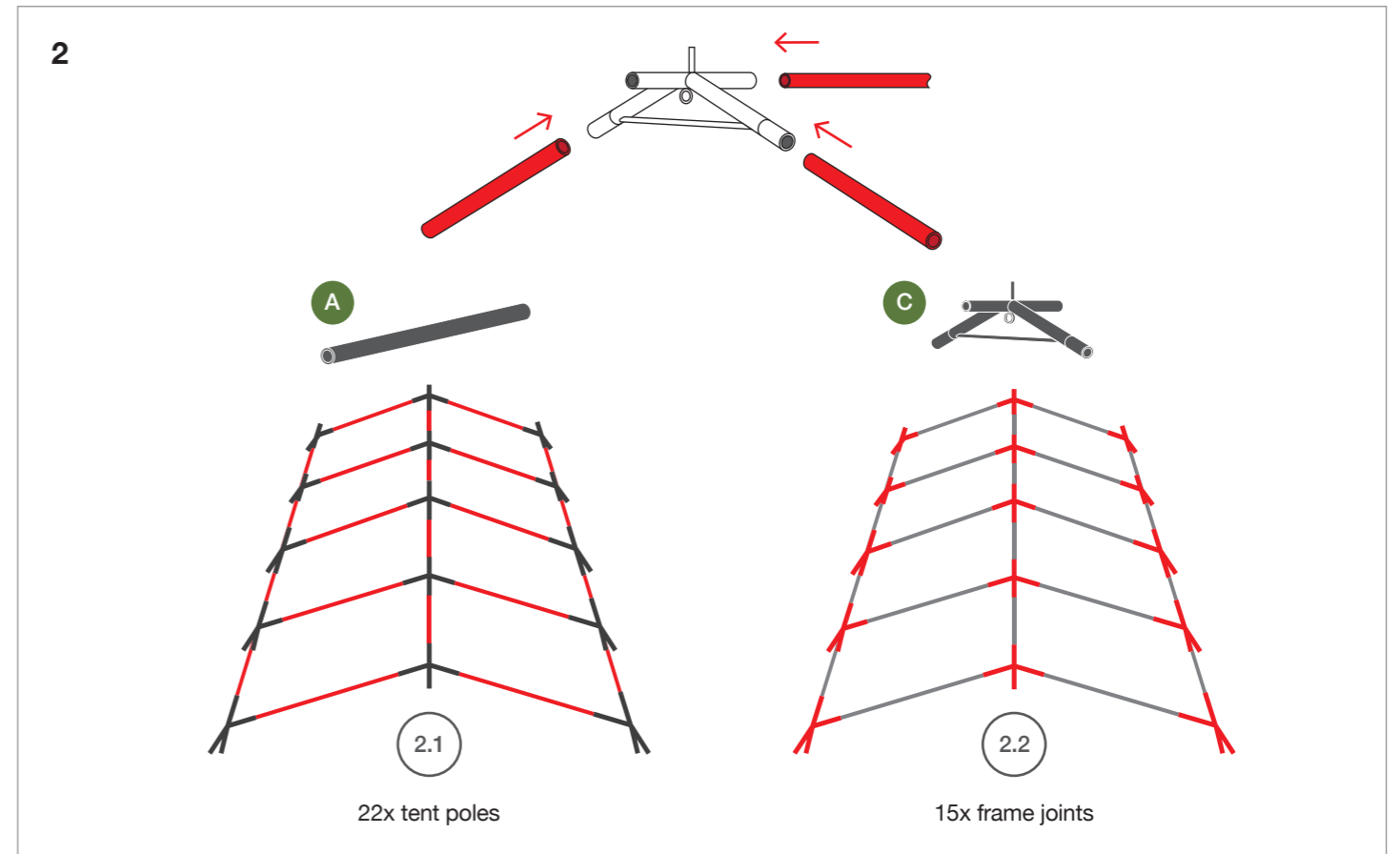

Slot the "A" poles into all the joints. **Note:** the longer parts of the joint should face to the side.

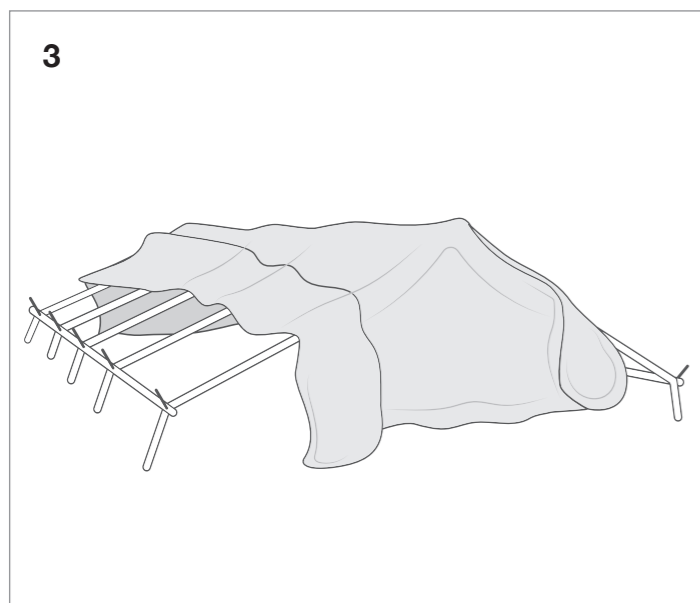

Spread the outer tent over the ridge pole.

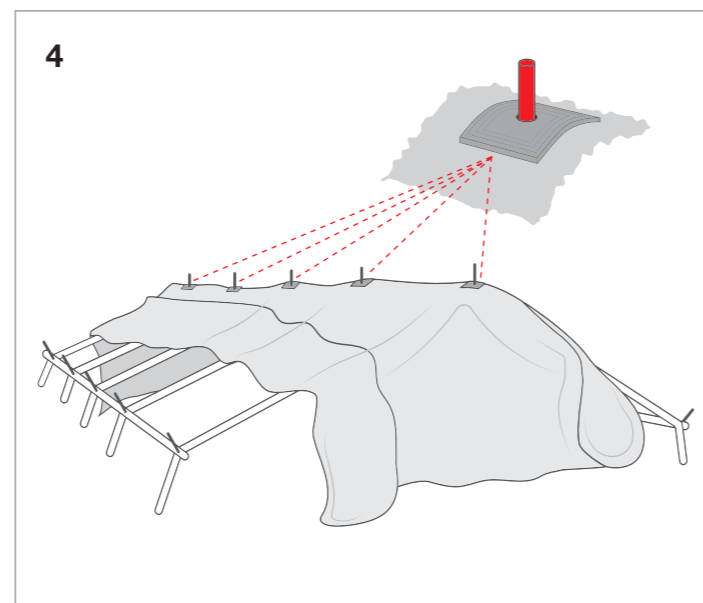

Secure the outer tent by inserting the apex joint pins through the eyelets.

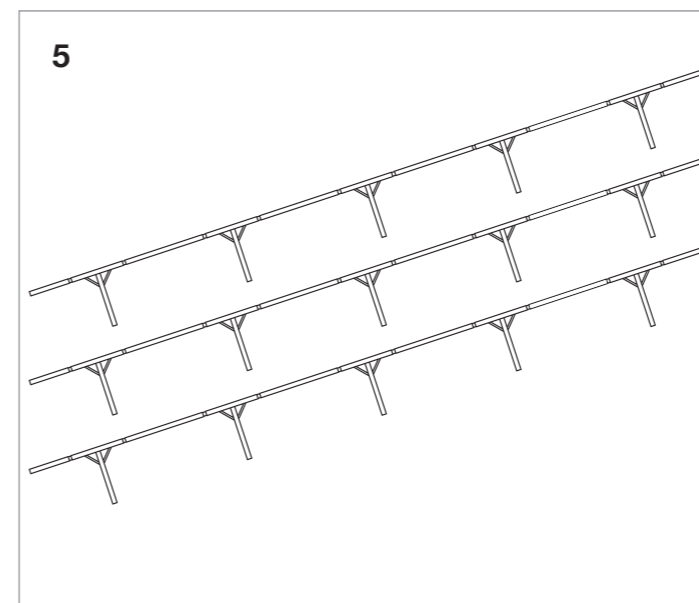

Assemble three identical shade net frames using "F" poles.

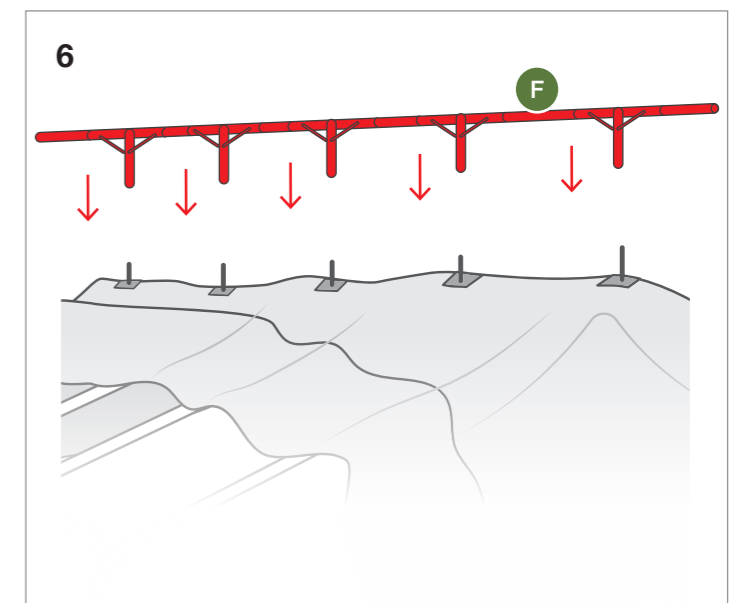

Slot one shade net frame onto the apex joint pins along the ridge pole.

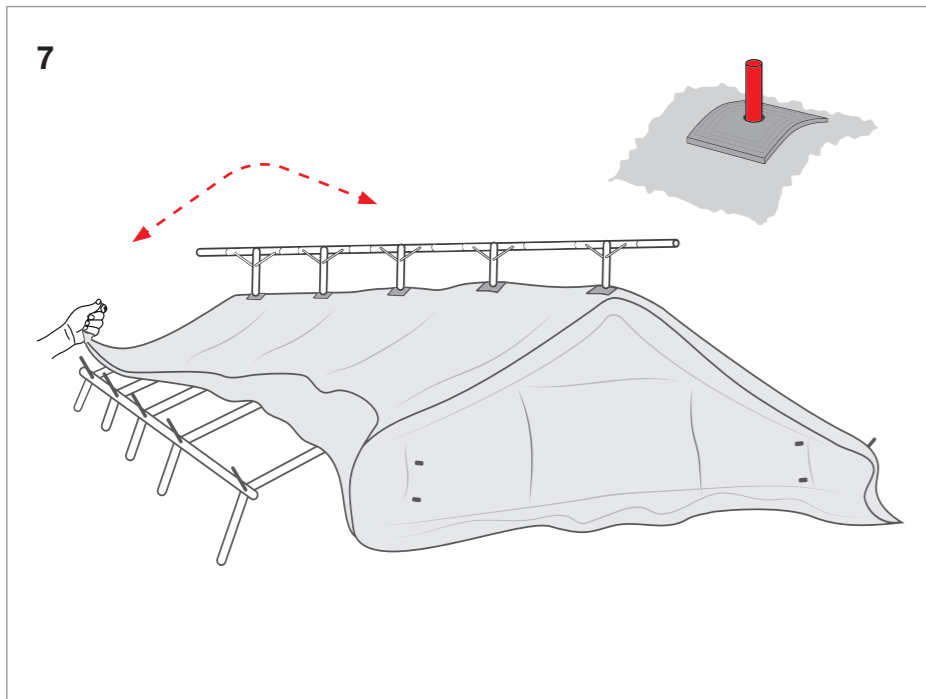

Spread out the outer tent and secure by inserting side joint pins through the eyelets. Ensure that the ends of the "A" poles are exposed

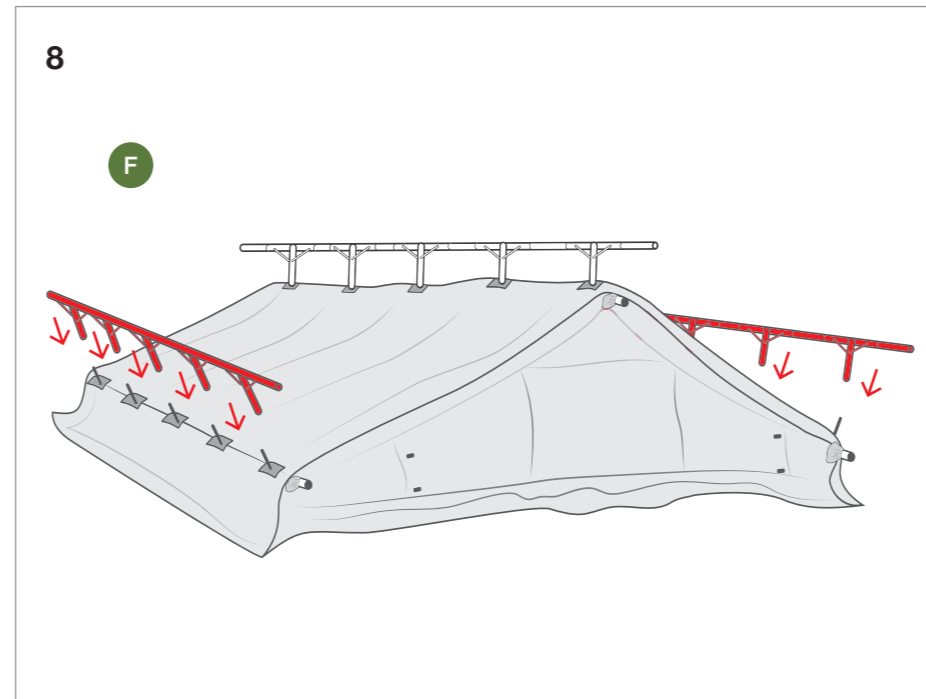

Slot a shade net frame onto the joint pins along the each side.

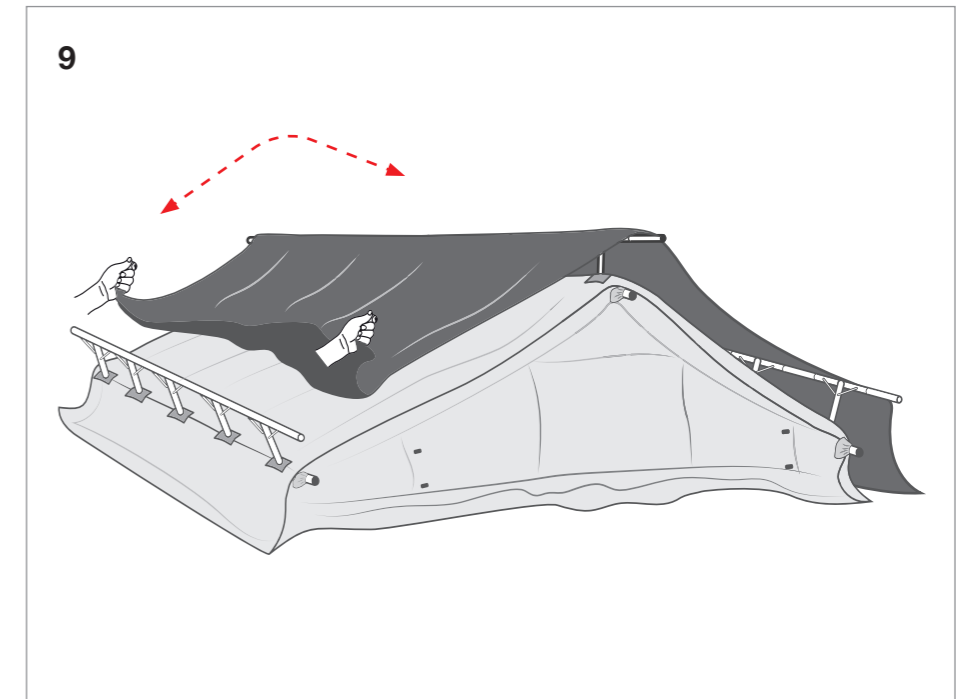

Spread the shade net over the top of the tent

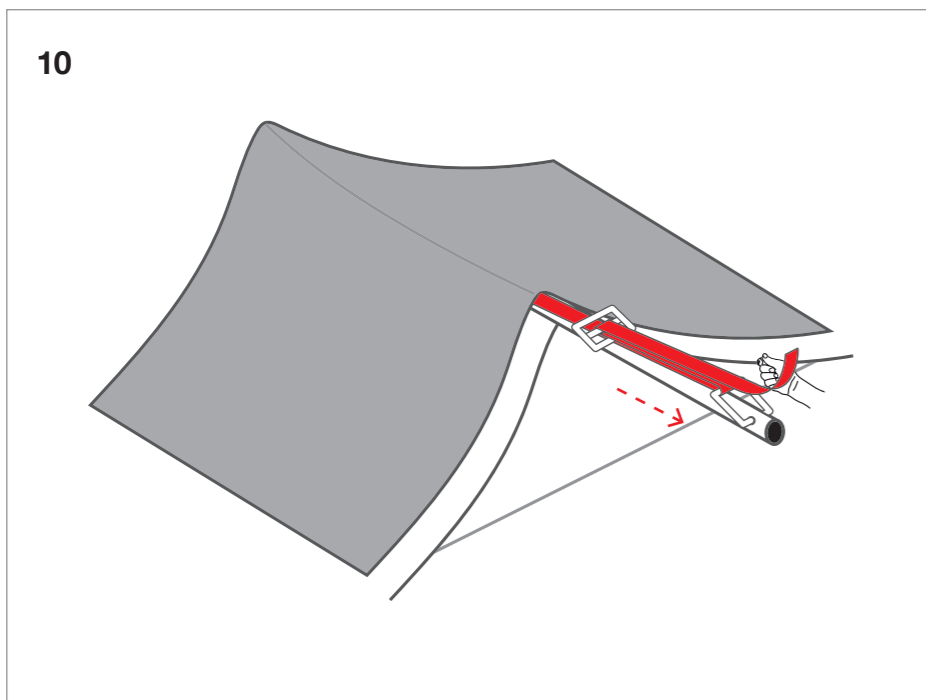

Secure the shade net to each end of the shade net frames using the buckles.

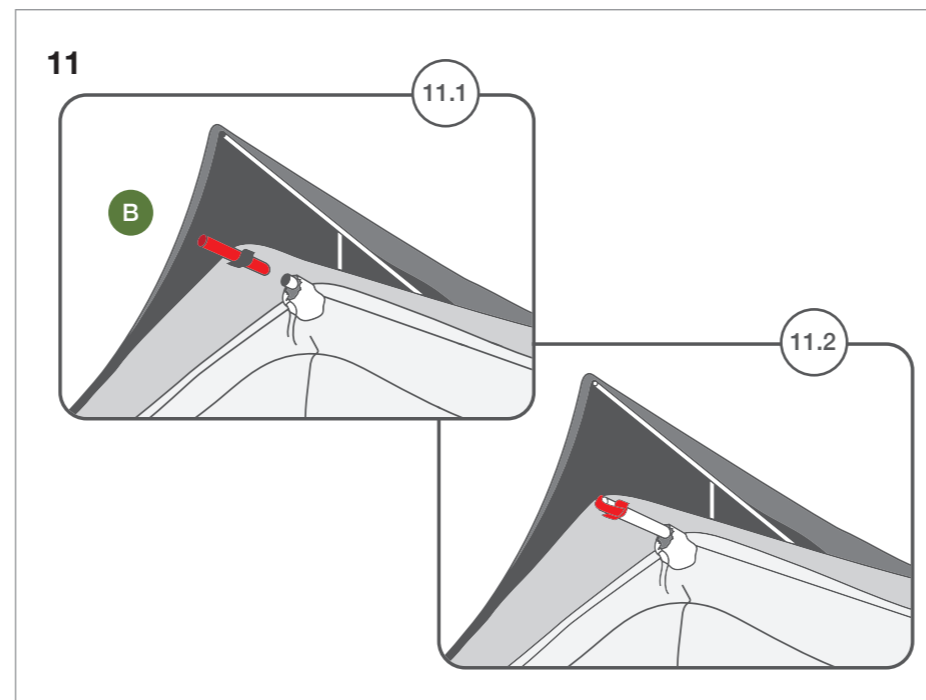

Connect "B" poles to the end of each "A" pole and secure with Velcro flaps.

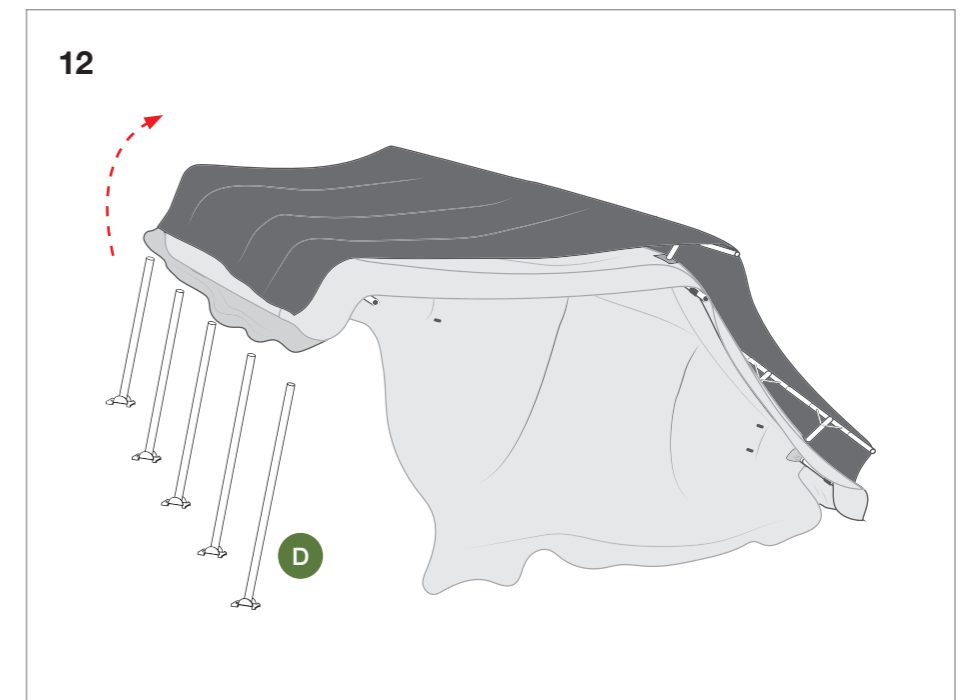

Lift the tent frame and insert the standing poles into the upper joints. Do the same for both sides of the tent.

13

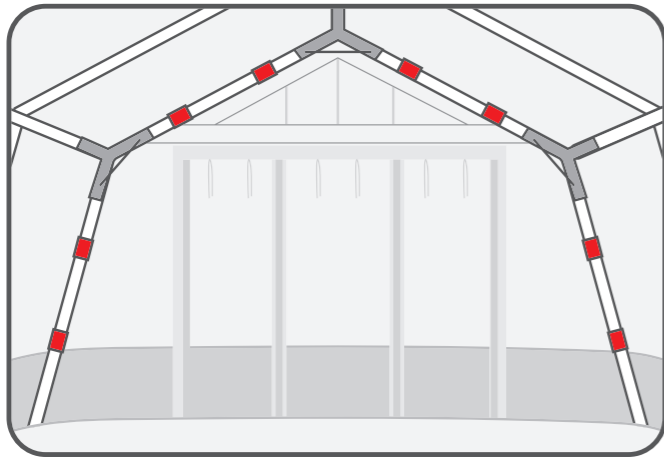

Fix the outer tent to all tent poles using the Velcro loops.

14

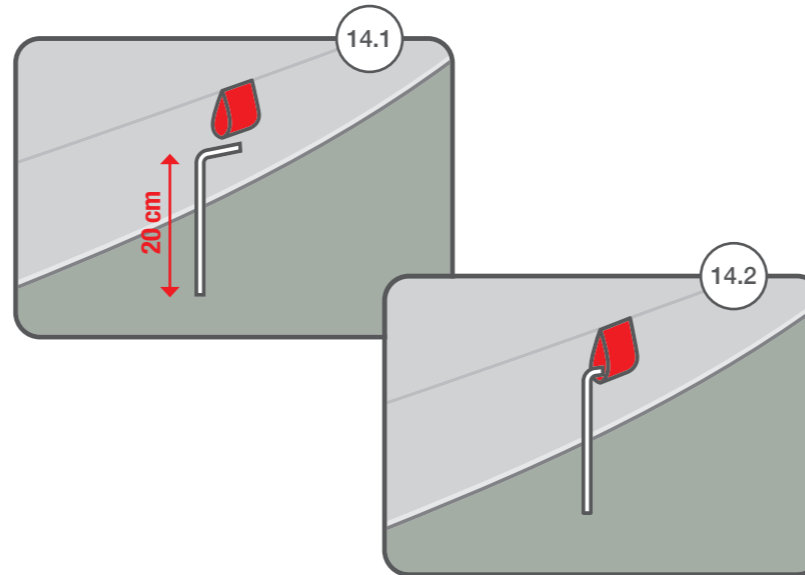

Inside the tent, secure all lower black loops with a steel pin, until 20cm remains exposed.

15

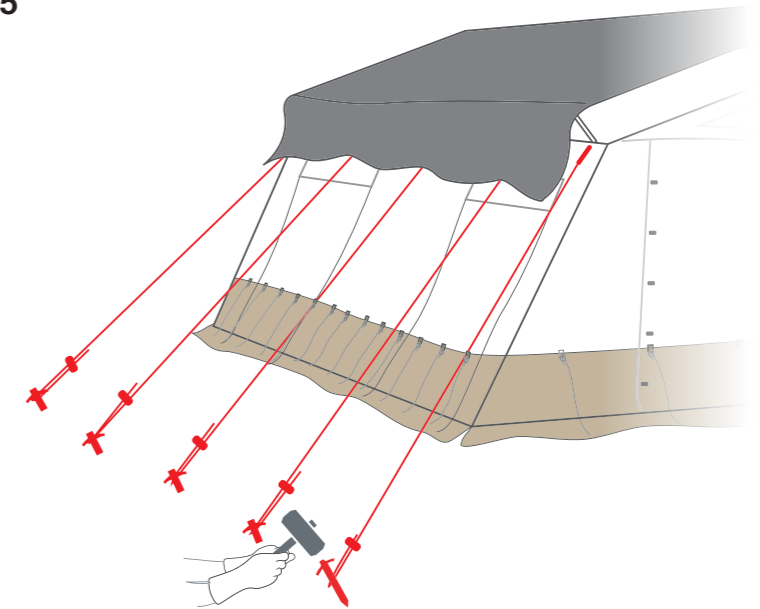

Pull out all guy ropes, secure with tent pegs, and tighten with sliders.

16

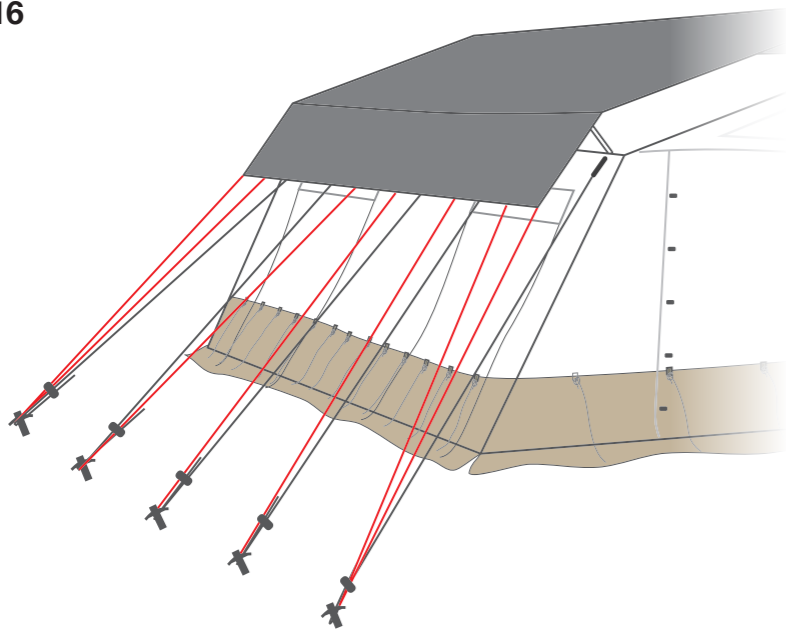

Pull out all shade net ropes and tie onto the appropriate tent pegs.

17

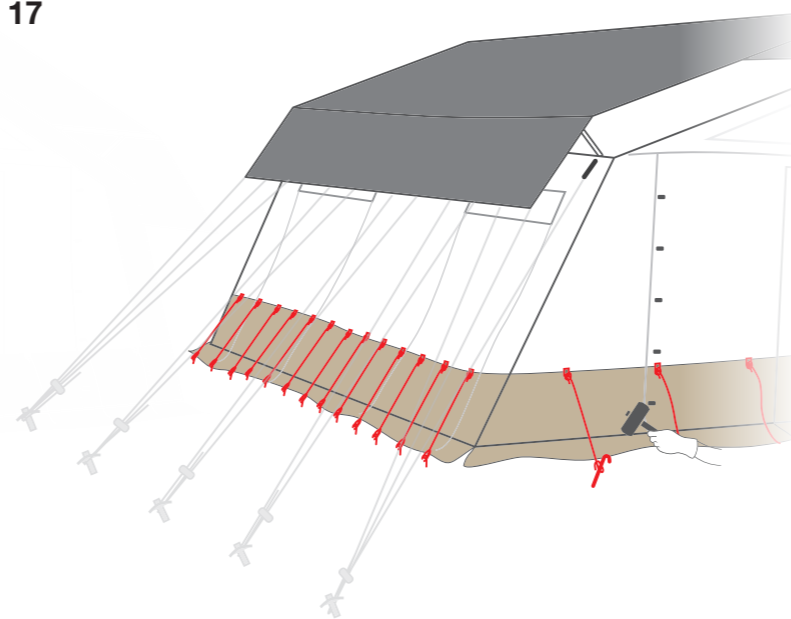

Pull out the outer tent skirt. Secure with twisted rod pegs. Tie the lower guy ropes to them. Note: gable end flaps should first be zipped.