



# Product Catalogue

2024



We



Photo Credit - Samaritan's Purse

**value-engineered  
solutions to the  
humanitarian sector**

# Contents

## 04 Our Mission and Vision

## 05 Our Perspective

## 06 Innovation & Sustainability

## 07 Family Tents

- 08 DomeHome Self-Standing Family Tent
- 09 GeoHome Family Tent
- 10 Cradle Tent
- 11 Viva Family Tent FR
- 12 Viva Family Tent
- 13 Viva Family Framed Tent

### Add-ons

- 14 Viva Winterization Kit
- 15 Winterization Module and Winterization Kit for GeoHome

## 16 Multipurpose Tents

- 17 Legend 33 Tent
- 18 Legend 45 Tent
- 19 LegendMEDI
- 20 Huggy Pro - HPT 24
- 21 Huggy Pro - HPT 36
- 22 Huggy Pro - HPT 48
- 23 Huggy Pro - HPT 72
- 24 Huggy 24
- 25 Huggy 42
- 26 Huggy 72
- 27 Dispensary Tent

### Add-ons for Huggy Pro - HPT

- 28 Inner Liner
- 29 Winter Liner
- 30 Hard Flooring
- 31 Solar Lighting Kit
- 32 Electrical Lighting Kit

## 33 Inflatable Tent

- 34 HuggyAir - HPT 72

## 35 Mobile Storage Units

- 36 Rex Hall MSU 6.5 x 8 m
- 37 Rex Hall MSU 10 x 24 m
- 38 Rex Hall MSU 10 x 32 m

### Add-ons

- 39 LED Lighting Kit
- Ballast Anchors
- Flexible Flooring System
- Hard Flooring System
- Fire Alarm System
- Mechanical Ventilation
- Windows
- Pedestrian Doors
- Lateral Linking Kit
- Solar Energy Systems

## 40 Core Relief Items

- 41 Woven Flexible Tarpaulin
- 42 Reinforced Plastic Tarpaulin
- 43 Coverage Kit
- 44 Viva Stove
- 45 Aquatainer 10L Collapsible
- 47 Aquatainer 20L Collapsible
- 48 Synthetic Sleeping Mat
- 49 Multipurpose Sleeping Mat
- 50 Viva Thermal Sleeping Mat
- 51 Pura Water Bucket
- 52 Jerry Bucket
- 53 Low Thermal Synthetic Blanket
- 54 Medium Thermal Synthetic Blanket
- 56 High Thermal Synthetic Blanket

## 58 Non-Standard Items

- 59 Bed Linen
- Hygiene Kit
- Bunk Bed
- Adult Diapers
- Steel Field Cot
- Pillow
- Sleeping Bag
- Mattress
- Thermos
- Towel
- Quilt



# Our Mission



NRS Relief is a purpose-driven company that designs, develops and delivers value-engineered solutions to the humanitarian sector. We create life-improving products in partnership with our clients, such as UN Agencies, International Organizations and NGOs worldwide.

We supply relief essentials, shelter solutions, multipurpose tents and mobile storage units, as well as customized products and logistics services.

# Our Vision



At the core of our business strategy lies a deep comprehension of our clients' work purpose. Our focus is on aligning our business capabilities with the needs and objectives of humanitarian and development organizations, which address urgent challenges like natural disasters and forced displacement. Our overarching objective is to deliver vital solutions that effectively improve the lives of affected individuals, while contributing to sustainable economic empowerment of the local community in Pakistan. To achieve this, we forge strategic partnerships with our manufacturing arm.



Shelter is a basic human right



Protect dignity; quality counts



Durability and cost-effective solutions



# Our Perspective



Continuous product innovation



Understanding local environment and beneficiaries' needs



Promote recycling and sustainability



## Shelter is far more than a roof and four walls

Shelter is a basic human need and is critical for survival in most disasters. At NRS Relief, we have developed shelter solutions for over 45 years, supplying refugee tents, multipurpose shelters, mobile storage units and core relief items, i.e. tarpaulins and blankets to UN agencies, international NGOs and bilateral donors. Our aim is to offer cost-effective, fit-for-purpose quality shelters and aid essentials, keeping the real needs of the beneficiaries in mind.



# Innovation & Sustainability

We believe that sustainable business makes smart business. For us, embracing a sustainable humanitarian supply chain is a way of honoring our purpose as a relief supplier. We see purpose-driven sustainability as our contribution towards social, environmental as well as economic progress.



**Economic**



**Social**



**Environmental**



## Economic responsibilities

We are committed to pioneering new solutions, sustainably creating fit-for-purpose products through value engineering. We focus on financial sustainability and pledge to continuously expand our portfolio of products and services. At the same time, as the industry leader we strive to progressively grow our business to ensure economic empowerment in our supply chain. Our vision is that all stakeholders should benefit from the life-improving products that we develop and design - from factory to the field.



## Social responsibilities

We focus on creating a safe, diverse, merit-based working environment that values teamwork yet allows for individual growth. We actively engage with the vibrant humanitarian community in Dubai and raise awareness for social causes such as the refugee crisis and women's empowerment. At the same time, we support our manufacturing arm in Pakistan with their community investment programs, aimed at building community resilience through improved health care services and educational opportunities. We also acknowledge the social impact of our products on the end-user - from refugee to aid worker. To honor this purpose, we develop and design products that respect beneficiaries' true needs and support the acceleration of the sustainable development goals.



## Environmental responsibilities

Minimizing our ecological footprint is an incentive rather than a burdensome exercise in compliance. We are committed to reducing emissions and waste, while seeking to recycle and reuse across the production processes wherever possible. We do so in close collaboration with our manufacturing arm as well as by launching green initiatives in our Dubai office and offices in Lahore.

As a manufacturer we have always been very conscious about material sourcing and optimal material use, and energy and water usage in our operations, as this has a direct impact on the operational costs and competitive position of the products we sell. In the last years we have made significant reductions in the energy and water usage in our operations with a greater focus on improving our sustainability performance. We are also working closely with our suppliers in order to reduce the carbon footprint of the materials we use. We are constantly researching production processes and material sources including the use of recycled materials and reduction of single use plastics. As a result, we initiated a project aiming at reducing the environmental impact and the carbon footprint of relief items, i.e. tarpaulins, blankets, jerrycans and buckets, targeting a 40% reduction in carbon emissions.



# Family Tents

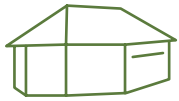

Discover our exceptional fire-retardant family tents, purpose-built to withstand the rigors of humanitarian settings. Our tents are made to last, providing reliable shelter for families in need.

Our range includes both the new-generation polyethylene self-standing tents and the classic poly-cotton family shelter, catering to different preferences and needs.

We take pride in ensuring that all our tents comply with recommended minimum living area standards in hot and moderate climates, providing a spacious 3.5 m<sup>2</sup> per person. For cold climates, we offer a winterization kit that adds an extra layer of protection against cold, wind, and snow, ensuring that families remain warm and comfortable throughout their stay.





## DomeHome Self-Standing Family Tent

UNHCR Standard



Fire retardant



Lightweight



Waterproof



Rot-proof



UV stabilized



Logo customizable



### › Key features

- New generation dome-shaped self-standing family tent
- 3-layers: outer tent, pre-fitted inner tent and shade cover
- PE fabric, lightweight and strong
- Interior allows standing in all corners for maximum space
- Adaptable to all climates. advanced ventilation
- Easy set-up (less than 30 minutes, 3 persons)
- UV resistance, FR and waterproof
- Durable and recyclable materials
- Accommodates five persons
- Rapid deployment in any emergency

### › Dimensions

<b>Total living area</b>	18.5 m <sup>2</sup>
<b>Centre height</b>	2.40 m
<b>Length</b>	4.30 m
<b>Width</b>	4.30 m
<b>Entrance wall height</b>	1.90 m
<b>Door height</b>	1.70 m

### › Materials

<b>Outer tent (roof, walls, mud flaps, partition, groundsheets)</b>	190 ±10% g/m <sup>2</sup> Polyethylene fabrics. Woven high-density polyethylene (HDPE) black film, coated with low-density polyethylene (LDPE) on both sides. Fire retardant under EN 13823 + A1 and CPAI84
<b>Inner</b>	150 ±15% g/m <sup>2</sup> Poly-cotton blend fabrics Fire retardant under CPAI84
<b>Mosquito net (doors, windows, ventilation)</b>	85-100 g/m <sup>2</sup> 100% Polyester, warpknitted 25 holes/cm <sup>2</sup>

### › Graphic reference

Front view

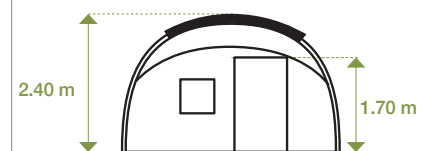

Top view

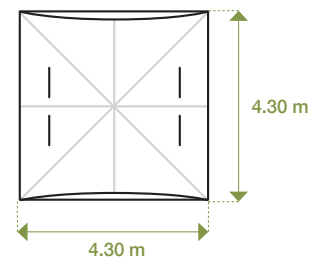

## GeoHome Family Tent

ICRC/IFRC/IOM Standard

 Fire retardant	 Waterproof	 Rot-proof	 UV stabilized	 Logo customizable
--	--	---	---	---

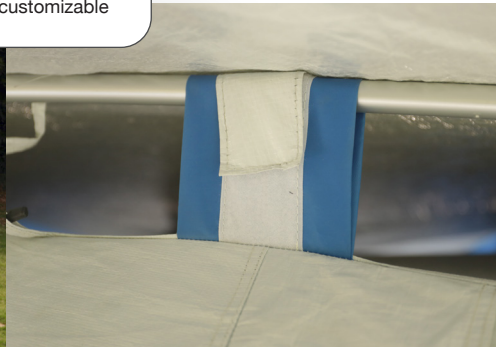

### › Key features

- New generation family tent, geodesic shape for more beneficiary comfort and safety
- Two-layer: outer tent and shade cover
- Fire retardant, waterproof and UV resistant
- Adaptable to all seasons. Optional inner liner and winter modules available
- Accommodates a family of five people
- Quick set-up, three persons in 30 minutes
- Can withstand wind loads up to 120 km/h
- Rapid deployment in any emergency on pallets or in cages

### › Dimensions

<b>Total living area</b>	19.6 m <sup>2</sup>
<b>Centre height</b>	2.40 m
<b>Length</b>	4.33 m
<b>Width</b>	5.58 m
<b>Door height</b>	1.70 m

### › Materials

<b>Outer tent (roof, walls, mud flaps, partition, groundsheets and shade fly)</b>	<p>Base fabric: Woven high-density polyethylene (HDPE) black fibres</p> <p>Coating: white low density polyethylene (LDPE) on both sides, 190 gsm</p> <p>Fire retardancy: EN13823+AI</p>
<b>Mosquito nets</b>	<p>Polyester. Outer tent: 7-9 holes per inch<sup>2</sup>.</p> <p>Inner tent: 20-25 holes per inch<sup>2</sup></p>
<b>Frame</b>	<p>All aluminium</p> <p>Main pipes: outer diameter 19 mm ±0.5 mm, thickness 1.2 mm ±1%,</p> <p>Connectors: outer diameter adapted to main pipe, thickness 1.5 mm ±1%</p>

### › Graphic reference

Front view

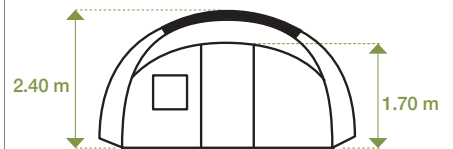

Top view

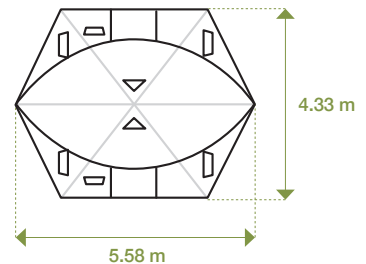



## Cradle Tent

Developed with UNHRD Lab

 Fire retardant	 Waterproof	 Rot-proof	 UV stabilized	 Eco friendly
--	--	---	---	--



Cradle cover glowing in the dark

### › Key features

- New generation family tent, geodesic shape
- 3-layer: Outer tent, inner tent and shade cover
- Adaptable to all climates
- Easy-setup (30 minutes, 3 persons)
- UV resistance, FR and waterproof
- Rapid deployment in any emergency
- This product has been developed with a focus on end-to-end sustainability as the family tent is provided with a box designed to be used as a cradle for babies including accessories made using upcycled materials

### › Dimensions

<b>Total living area</b>	19.6 m <sup>2</sup>
<b>Centre height</b>	2.40 m
<b>Length</b>	4.33 m
<b>Width</b>	5.58 m
<b>Wall height</b>	Dome-shaped
<b>Door height</b>	1.80 m (1.7 m inner tent)

### › Materials

<b>Outer tent (roof, walls, mud flaps, partition, groundsheets and shade fly)</b>	Base fabric: Woven high-density polyethylene (HDPE) black fibres Coating: White low density polyethylene (LDPE) on both sides, 190 gsm. Fire retardancy: EN13823+AI
<b>Inner tent</b>	Polycotton, White, 125 gsm ±5%
<b>Mosquito nets</b>	Polyester. Outer tent: 7-9 holes per inch <sup>2</sup> Inner tent: 20-25 holes per inch <sup>2</sup>
<b>Frame</b>	All aluminium main pipes: outer diameter 19 mm ±0.5 mm, thickness 1.2 mm ±1% Connectors: outer diameter adapted to main pipe, thickness 1.5 mm ±1%

### › Graphic reference

Front view

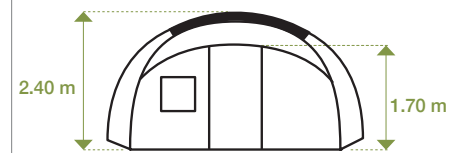

Top view

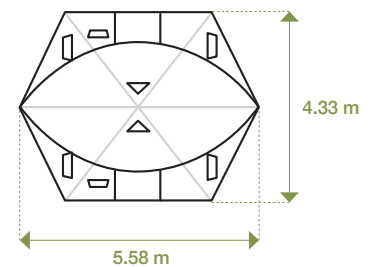

Cradle box

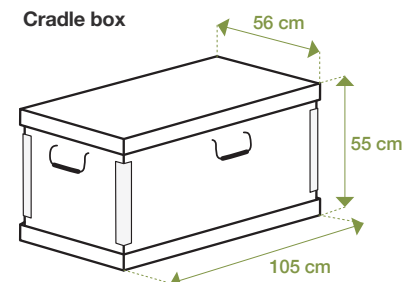



## Viva Family Tent

UNHCR Standard

 Fire retardant	 Waterproof	 Rot-proof	 UV stabilized	 Logo customizable
--	--	---	---	---



### › Key features

- Fire retardant, waterproof, rotproof and UV-stabilised
- 16 m<sup>2</sup> main floor area plus two 3.5 m<sup>2</sup> vestibules for a total area of 23 m<sup>2</sup>, double-fly with ground sheet
- Complies to recommended minimum living area in hot and temperate climates (3.5 m<sup>2</sup> per person), providing extra space for cold climates
- Suitable for a family of five people

### › Dimensions

<b>Total living area</b>	23 m <sup>2</sup>
<b>Main floor</b>	16 m <sup>2</sup>
<b>Two vestibule area</b>	3.5 m <sup>2</sup> x 2 = 7 m <sup>2</sup>
<b>Centre height</b>	2.20 m
<b>Width</b>	4.00 m
<b>Ridge length</b>	4.00 m
<b>Side wall height</b>	1.25 m
<b>Centre base length</b>	6.60 m

#### Tent doors (width and height)

<b>Total size</b>	1.30 x 1.40 m
<b>Door flaps</b>	1.40 x 1.60 m
<b>Upper part</b>	1.40 x 0.90 m (PC)
<b>Lower part</b>	1.40 x 0.70 m (PE)

#### Upright poles

<b>2 Upright poles</b>	2.20 m
<b>1 Centre upright pole</b>	2.17 m
<b>Pole diameter</b>	25 x 1.20 m

#### Side poles

<b>6 Side poles</b>	1.25 m
<b>4 door poles</b>	1.40 m
<b>Pole diameter</b>	19 x 1.25 m

### › Graphic reference

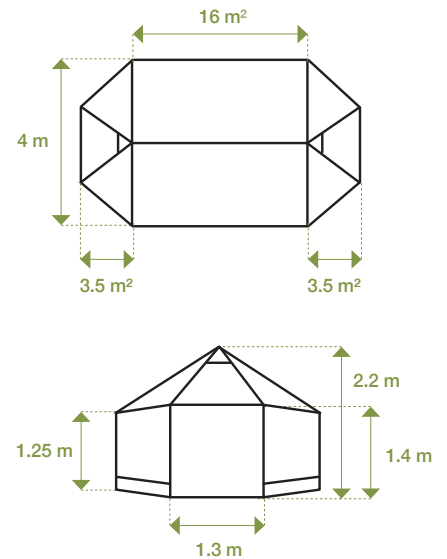

## Viva Family Tent

ICRC/IFRC Standard

 Waterproof	 Rot-proof	 UV stabilized	 Logo customizable
--	---	---	---



### › Key features

- Waterproof, rotproof and UV-stabilised
- 16 m<sup>2</sup> main floor area plus two 3.5 m<sup>2</sup> vestibules
- Large windows (360 cm wide and 60 cm high)
- Minimum living area in hot and temperate climates
- Suitable for a family of five people

### › Dimensions

<b>Total living area</b>	23 m <sup>2</sup>
<b>Main floor</b>	16 m <sup>2</sup>
<b>Two vestibule area</b>	3.5 m <sup>2</sup> x 2 = 7 m <sup>2</sup>
<b>Centre height</b>	2.20 m
<b>Width</b>	4.00 m
<b>Ridge length</b>	4.00 m
<b>Side wall height</b>	1.25 m
<b>Centre base length</b>	6.60 m

#### Tent doors (width and height)

<b>Total size</b>	1.30 x 1.40 m
<b>Door flaps</b>	1.40 x 1.60 m
<b>Upper part</b>	1.40 x 0.90 m (PC)
<b>Lower part</b>	1.40 x 0.70 m (PE)

#### Upright poles

<b>2 Upright poles</b>	2.20 m
<b>1 Centre upright pole</b>	2.17 m
<b>Pole diameter</b>	25 x 1.20 m

#### Side poles

<b>6 Side poles</b>	1.25 m
<b>4 door poles</b>	1.40 m
<b>Pole diameter</b>	19 x 1.25 m

### › Graphic reference

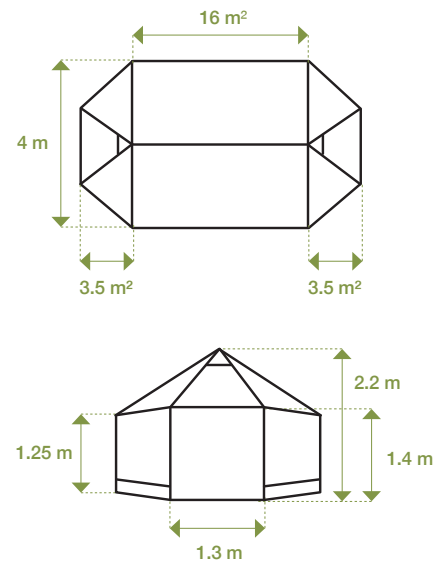



## Viva Family Frame Tent

ICRC/IFRC Standard

Easy to set up	Waterproof	Rot-proof	UV stabilized	Logo customizable
----------------	------------	-----------	---------------	-------------------



### › Key features

- Waterproof, rotproof and UV-stabilised
- Easy to set up and to erect in fewer surface
- The symmetric flaps offer the possibility to join two tents together lengthwise to create larger units
- Fit for emergency situations, in all climates
- Suitable for a family of five people

### › Dimensions

<b>Centre height</b>	2.4 m
<b>Width</b>	4.15 m
<b>Ridge length</b>	4 m
<b>Side wall height</b>	1.50 m
<b>Door height</b>	1.6 m
<b>Centre base length</b>	5.2 m

#### Front doors (width and height)

<b>Size</b>	1.5 x 1.5 m
<b>Door flaps</b>	1.5 x 1.6 m
<b>Upper part</b>	1.5 x 1.08 m (made of canvas)
<b>Lower part</b>	1.5 x 0.52 m (made of woven PE)

#### Rear doors (width and height)

<b>Size</b>	1.0 x 2.1 m
<b>Door flaps</b>	1.0 x 2.1 m
<b>Upper part</b>	1.0 x 1.58 m (made of canvas)
<b>Lower part</b>	1.0 x 0.52 m (made of woven PE)

### › Graphic reference

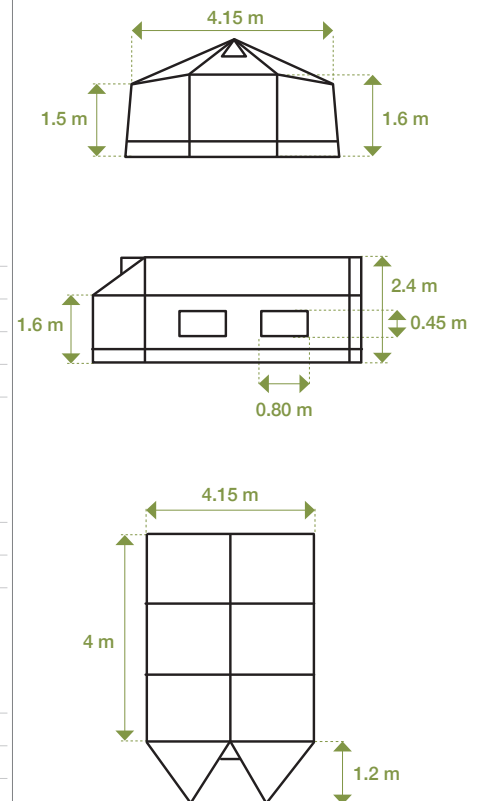



## Viva Winterization Kit

ICRC/IFRC Standard

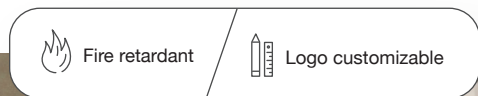

### › Key features

- Specially designed for Viva Family Tents to improve the insulation against cold climates
- The kit includes the following items:
  - 5 insulated sleeping mats
  - 1 winterization liner
  - 1 partition
  - 1 heat-resistant floor protection (for stove) and
  - 1 heat-resistant chimney sleeve
- All components are fire retardant to the level of CPAI84 regulation
- All materials and additives are non-toxic, free from asbestos and other toxic products according to the EC regulations
- Individually packed in a strong, waterproof plastic bag made of standard plastic tarpaulin
- In case FR tent is used, no partition in the kit is to be supplied as the same is available in the tent itself

### › Insulated flooring mats

Designed to protect families against cold from the ground or in any other floors during cold weather

<b>Dimensions</b>	1.8 x 0.9 m per mat
<b>1st layer, plastic floor mat</b>	Tight woven twill structure, double thickness, virgin PP multifilament 500 deniers in the warp, minimum 1,000 tubes/meter, 500 gsm minimum weight
<b>2nd layer, aluminized canvas</b>	Synthetic canvas with durable aluminium coating
<b>3rd layer, fleece blanket</b>	Refer to our Medium Thermal Synthetic Blanket
<b>Design</b>	Heavy-duty ribbon strongly stitched all around the mat

### › Graphic reference

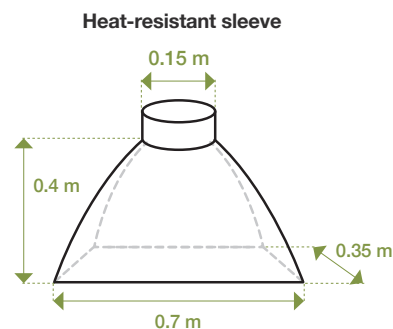
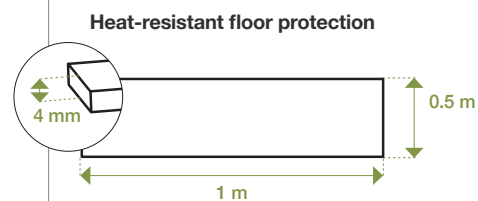
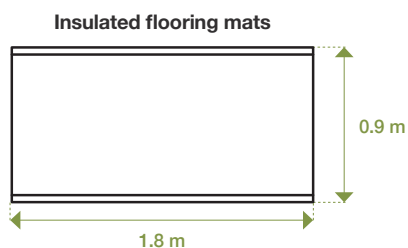

## Winterization Module for GeoHome Family Tent



Fire retardant



Snow and wind protection



## Winterization Kit for GeoHome Family Tent



Fire retardant



Cold and wind protection



### › Key features

- Specifically designed to winterize GeoHome, the geodesic family tent ICRC/IFRC/IOM specifications
- An insulated winter cover to be placed directly over the family tent to keep the warmth inside and prevent heat loss
- An extra layer of protection against cold, wind and snow
- Fire retardant, waterproof and UV resistant
- Including fireproof chimney patch and flue pipe sleeves for the placement of the stove inside the tent
- Adding 8.4 m<sup>2</sup> space in its front and back vestibules areas
- Quick set-up, 3 people in 20 minutes
- Rapid deployment in any emergency on pallets or in cages

### › Dimensions

<b>Total living area</b>	27.00 m <sup>2</sup>
<b>Total vestibule area</b>	8.40 m <sup>2</sup>
<b>Centre height</b>	2.40 m
<b>Length</b>	7.73 m
<b>Width</b>	5.58 m
<b>Door width and height</b>	1.60 x 1.65 m

### › Materials

<b>Winter cover (roof, walls, snow flaps)</b>	Base fabric: Woven high-density polyethylene (HDPE) black fibers, Coating: white low-density polyethylene (LDPE) on both sides, 190 gsm, Fire retardancy: EN13823+AI
<b>Window cover</b>	Polyester mesh, 20-25 holes per inch <sup>2</sup>

### › Key features

- Specifically designed to winterize GeoHome, the geodesic family tent of ICRC/IFRC/IOM specifications
- An insulated winter tent, attached to a sewn-in bathtub type ground sheet, is to be placed directly in the family tent to keep the warmth inside and prevent heat loss
- Helps regulate temperature and reduce condensation inside the tent
- An extra layer of protection against extreme cold and strong winds
- Flame retardant and rot-proof

### › Dimensions

<b>Centre height</b>	2.20 m
<b>Length and width</b>	5.35 x 4.10 m

### › Materials

<b>Winter liner</b>	Winter liner is made in 3 layers of quilted fabric: the outer and inner layer is made of 100 GSM poly/cotton blended fabric, and the middle layer is of 80 GSM polyester wadding
<b>Ground sheet</b>	It has an integrated/sewed ground sheet like a bathtub in PE – 180 GSM approx.



# Multipurpose Tents





Introducing our versatile range of multipurpose tents, the must-have equipment for emergency response and humanitarian programs. These tents serve a variety of purposes, including medical and office space, classrooms, and accommodations. Customize your tents with optional add-ons such as liners, lighting kits, and flooring to fulfill all your specific requirements. We are excited to present our latest addition to the collection - the HuggyPro - HPT tents. These sustainable tents have been designed to incorporate frequently requested features, providing an all-in-one solution.





## Legend 33 Tent

ICRC/IFRC Standard

 Fire retardant (optional)	 Waterproof	 Rot-proof	 UV stabilized	 Logo customizable
---	--	---	---	---



### › Key features

- Multipurpose tent which can be used for schooling, office, clinic, health centre, storage or temporary shelter purposes and can be attached to one another to make a longer structure
- Separate ground sheet for use in tent is available as option in case main tent is used for living conditions / clinics
- For hot climates shade net with frame is also available as option
- For increase protection from heat, cold, wind, dust, and insects an Inner tent with sewed in bath tub type ground sheet is available as an option
- Suitable for 15-30 persons

### › Dimensions

#### Outer tent

<b>Total size</b>	6 x 5.62 m
<b>Ridge height</b>	3.00 m
<b>Side wall height</b>	2.10 m

#### Inner tent

<b>Total size</b>	5.70 x 5.33 m
<b>Ridge height</b>	2.80 m
<b>Side wall height</b>	1.95 m

### › Materials

<b>Outer tent</b>	Roof, wall fabric: Poly-Cotton blended fiber yarns, 310 gsm - 315 gsm, 320 gsm in finished state for the walls
<b>Mud flaps</b>	PVC coated fabric polyester 1100 dtex, PVC coated 2 sides 540 gsm

### › Graphic reference

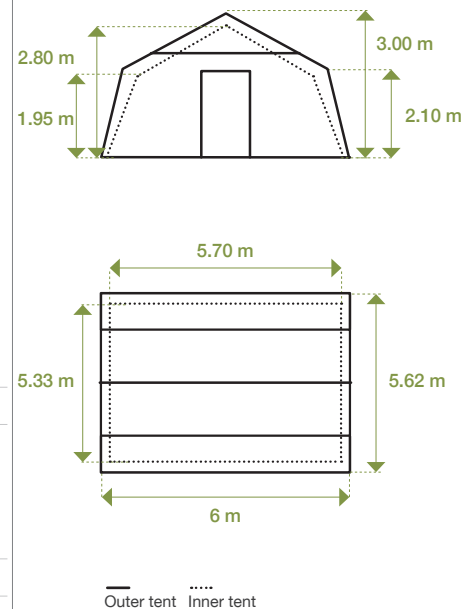

## Legend 45

MSF/ICRC/IFRC Standard

 Fire retardant (optional)	 Waterproof	 Rot-proof	 UV stabilized	 Logo customizable
---	--	---	---	---



### › Key features

- Multipurpose tent which can be used for schooling, office, clinic, health centre, storage or temporary shelter purposes and can be attached to one another to make a longer structure
- Separate ground sheet for use in tent is available as option in case main tent is used for living conditions / clinics
- A shade net is available as an optional accessory in hot climates
- Set of 5 partitions to create separate areas and a closed cabin inside the tent is available as option
- To increase protection from heat, cold, wind, dust, and insects, an Inner tent with a sewn-in bathtub-type ground sheet is available as an option
- Suitable for 20-40 person

### › Dimensions

#### Outer tent

<b>Total size</b>	7.50 x 6.00 m
<b>Ridge height</b>	3.00 m
<b>Side wall height</b>	2.10 m

#### Inner tent

<b>Total size</b>	7.20 x 5.70 m
<b>Ridge height</b>	2.80 m
<b>Side wall height</b>	1.95 m

### › Materials

<b>Outer tent</b>	Roof, wall: Poly-Cotton blended fiber yarns, 440 gsm for the roof, 320gsm in finished state for the walls
<b>Mud flaps</b>	PVC coated fabric polyester 1100 dtex, PVC coated 2 sides 540 gsm

### › Graphic reference

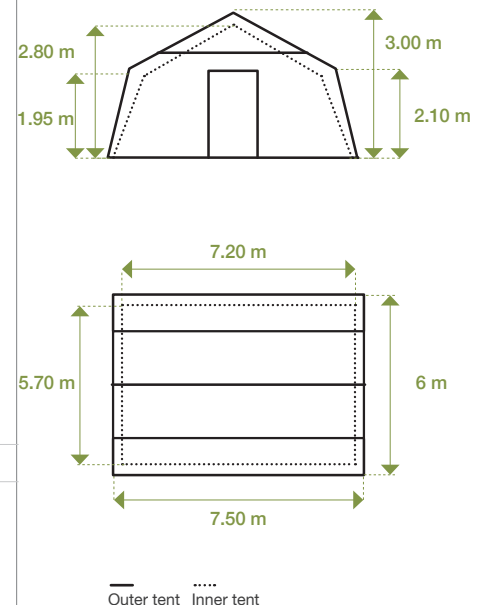



## LegendMEDI

MSF Standard



### › Key features

- This tent is designed in response to the Ebola epidemic in 2014. The medical tent can be deployed in case of haemorrhagic fever outbreaks such as Ebola and Lassa. Also, it can be deployed in cases of outbreaks of infectious diseases such as cholera
- It offers solutions such as treatment and isolation rooms for both suspected and confirmed patients
- The individual cabins for suspected patients prevent cross-contamination between infected and healthy patients
- The medical tent is constructed in a way that no (infected) material can accumulate on the surface of the tent, in seams or other parts
- The tent is designed to allow freedom of movement and easy operation like opening/ closing of the doors with magnetic closures, wearing protective clothing
- The special treatment cabins and other accessories are made of PVC coated polyester or polyethylene tarpaulin with non- corrosive accessories, whereby all seams and attachment points which might get in touch with patients, are heat or HF welded
- All tent components can be disinfected with chlorine-based disinfectants or other commonly used detergents
- It can be erected on various soil conditions and in different climate conditions, from moderate to tropical

### › Dimensions

<b>Cabin for confirmed patients</b>	4.2 x 7.2 x 2 m = total floor space 30.2 m <sup>2</sup> Door opening of 1.8 x 1 m
<b>Cabin for suspected patients &amp; Examination rooms - 4 cabins</b>	2 cabins (2 rooms per cabin) 4.2 x 3.5 x 2 m = total floorspace 14.7 m <sup>2</sup> Total floorspace 2 cabins (total 4 cabins) = 29.4 m <sup>2</sup> Total floorspace per room = 7.3 m <sup>2</sup>
<b>Partition panels</b>	2 x 2 m
<b>Shade net</b>	6.5 x 8 m
<b>Canopy shade net</b>	6.5 x 4 m

### › Graphic reference

#### Cabin for confirmed patients



#### Cabin for suspected patients - 4 cabins

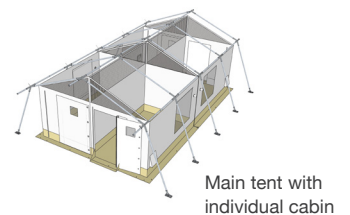

#### Examination cabin

Designed for examining patients by a doctor while family members can watch safely from behind the window.

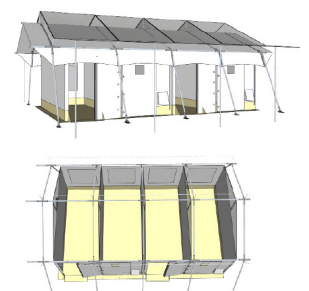



## Huggy Pro - HPT 24

UNICEF Standard

 Fire retardant	 Waterproof	 Rot-proof	 UV stabilized	 All climate zones
--	--	---	---	---



### › Key features

- Huggy Pro - High Performance Multipurpose Tent made of high quality and durable materials, ensuring a strong construction
- Solution is comprised of outer cover, shade net, groundsheet and partition
- A spacious 24 m<sup>2</sup> tent with vertical walls for optimum use of inner space
- Cost-efficient, lightweight and compact packing
- Strong and lightweight high tensile steel frame structure to withstand high wind and snow loads
- Rot and mildew proof, easy to clean and disinfect, resistant to commonly used disinfectants and detergents
- High performing in hot, cold and wet weather conditions; does not 'heat up' in direct sunlight, blocks UV, does not break or absorb moisture in below zero temperatures
- High comfort thanks to advanced ventilation and large mesh windows
- Environmentally friendly: low energy production process, fully recyclable, safely disposable by burning or burying when recycling is not possible

### › Dimensions

<b>Total size</b>	24 m <sup>2</sup>
<b>Floor size</b>	6.0 x 4.0 m (±1%)
<b>Central height outer tent</b>	3.00 m (±1%)
<b>Wall height outer tent</b>	2.05 m (±1%)
<b>Structure</b>	Lightweight tubular steel frame structure
<b>Window size</b>	135 x 135 cm
<b>Ventilation grates</b>	135 x 20 cm

#### Add-ons

- Inner liner
- Winter liner with insulated flooring
- Hard flooring
- Electrical lighting kit
- Solar lighting kit

### › Graphic reference

Front view

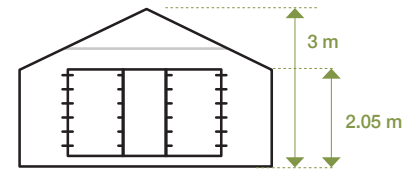

Side view (Window and ventilation)



Top view

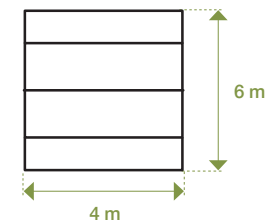



## Huggy Pro - HPT 36

UNICEF Standard

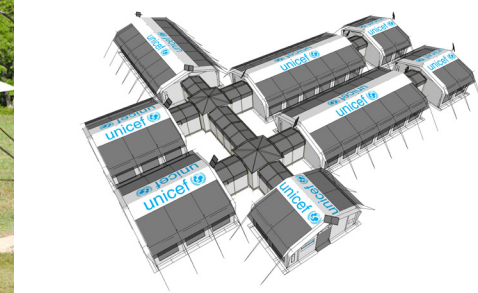

### › Key features

- Huggy Pro - High Performance Multipurpose Tent made of high quality and durable materials, ensuring a strong construction
- Solution is comprised of outer cover, shade net, groundsheet and partition
- A spacious 36 m<sup>2</sup> tent with vertical walls for optimum use of inner space
- Cost-efficient, lightweight and compact packing
- Strong and lightweight high tensile steel frame structure to withstand high wind and snow loads
- Rot and mildew proof, easy to clean and disinfect, resistant to commonly used disinfectants and detergents
- High performing in hot, cold and wet weather conditions; does not 'heat up' in direct sunlight, blocks UV, does not break or absorb moisture in below zero temperatures
- High comfort thanks to advanced ventilation and large mesh windows
- Environmentally friendly: low energy production process, fully recyclable, safely disposable by burning or burying when recycling is not possible

### › Dimensions

<b>Total size</b>	36 m <sup>2</sup>
<b>Floor size</b>	6.0 x 6.0 m (±1%)
<b>Central height outer tent</b>	3.00 m (±1%)
<b>Wall height outer tent</b>	2.05 m (±1%)
<b>Structure</b>	Lightweight tubular steel frame structure
<b>Window size</b>	135 x 135 cm
<b>Ventilation grates</b>	135 x 20 cm

#### Add-ons

- Inner liner
- Winter liner with insulated flooring
- Hard flooring
- Electrical lighting kit
- Solar lighting kit

### › Graphic reference

Front view

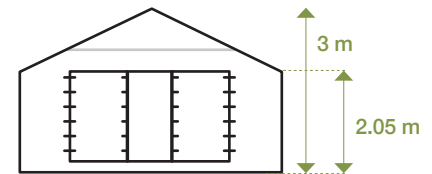

Side view (Window and ventilation)



Top view

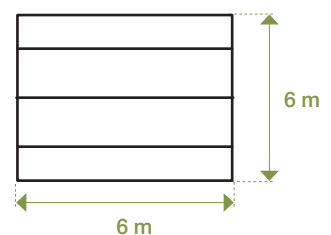

## Huggy Pro - HPT 48

UNICEF Standard

 Fire retardant	 Waterproof	 Rot-proof	 UV stabilized	 All climate zones
--	--	---	---	---



### › Key features

- Huggy Pro - High Performance Multipurpose Tent made of high quality and durable materials, ensuring a strong construction
- Solution is comprised of an outer cover, shade net, groundsheet and partition
- A spacious 48 m<sup>2</sup> tent with vertical walls for optimum use of inner space
- Cost-efficient, lightweight and compact packing
- Strong and lightweight high tensile steel frame structure to withstand high wind and snow loads
- Rot and mildew proof, easy to clean and disinfect, resistant to commonly used disinfectants and detergents
- High performing in hot, cold and wet weather conditions; does not 'heat up' in direct sunlight, blocks UV, does not break or absorb moisture in below zero temperatures
- High comfort thanks to advanced ventilation and large mesh windows
- Environmentally friendly: low energy production process, fully recyclable, safely disposable by burning or burying when recycling is not possible

### › Dimensions

<b>Total size</b>	48 m <sup>2</sup>
<b>Floor size</b>	6.0 x 8.0 m (±1%)
<b>Central height outer tent</b>	3.00 m (±1%)
<b>Wall height outer tent</b>	2.05 m (±1%)
<b>Structure</b>	Lightweight tubular steel frame structure
<b>Window size</b>	135 x 135 cm
<b>Ventilation grates</b>	135 x 20 cm

#### Add-ons

- Inner liner
- Winter liner with insulated flooring
- Hard flooring
- Electrical lighting kit
- Solar lighting kit

### › Graphic reference

Front view

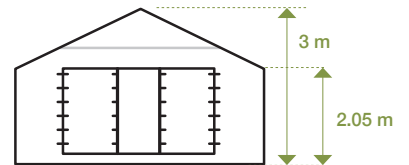

Side view (Window and ventilation)



Top view

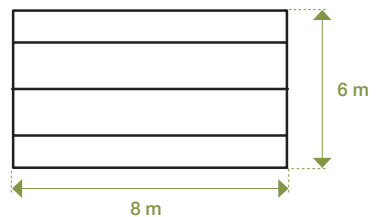



## Huggy Pro - HPT 72

UNICEF Standard



### › Key features

- Huggy Pro - High Performance Multipurpose Tent made of high quality and durable materials, ensuring a strong construction
- Solution is comprised of an outer cover, shade net, groundsheet and partition
- A spacious 72 m<sup>2</sup> tent with vertical walls for optimum use of inner space
- Cost-efficient, lightweight and compact packing
- Strong and lightweight high tensile steel frame structure to withstand high wind and snow loads
- Rot and mildew proof, easy to clean and disinfect, resistant to commonly used disinfectants and detergents
- High performing in hot, cold and wet weather conditions; does not 'heat up' in direct sunlight, blocks UV, does not break or absorb moisture in below zero temperatures
- High comfort thanks to advanced ventilation and large mesh windows
- Environmentally friendly: low energy production process, fully recyclable, safely disposable by burning or burying when recycling is not possible

### › Dimensions

<b>Total size</b>	72 m <sup>2</sup>
<b>Floor size</b>	6.0 x 12.0 m (±1%)
<b>Central height outer tent</b>	3.00 m (±1%)
<b>Wall height outer tent</b>	2.05 m (±1%)
<b>Structure</b>	Lightweight tubular steel frame structure
<b>Window size</b>	135 x 135 cm
<b>Ventilation grates</b>	135 x 20 cm

#### Add-ons

- Inner liner
- Winter liner with insulated flooring
- Hard flooring
- Electrical lighting kit
- Solar lighting kit

### › Graphic reference

Front view

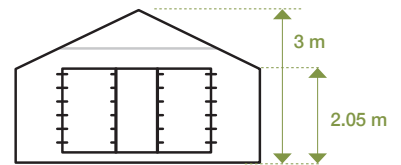



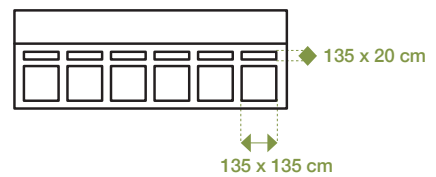

Side view (Window and ventilation)

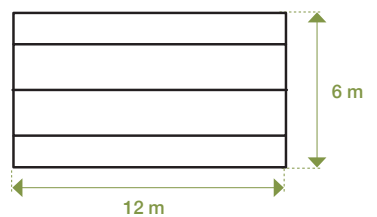

Top view



## Huggy 24

 Fire retardant	 Waterproof	 Rot-proof	 UV stabilized	 All climate zones
--	--	---	---	---



### › Key features

- Waterproof, rot-proof and UV-stabilized
- Lightweight, rectangular and framed tent that can be used for schooling, storage or temporary shelter purposes (comes in three sizes)
- Outer tent fabric is made of 450 - 455 g/m<sup>2</sup> PVC coated fabric, natural white
- Marking and logo customised to your requirements

### › Dimensions

#### Outer tent

<b>Total size</b>	6 x 4 m
<b>Centre height</b>	2.80 m
<b>Wall height</b>	1.95 m

#### Inner tent

<b>Centre height</b>	2.30 m
<b>Wall height</b>	1.80 m

### › Materials

<b>Outer tent</b>	450 - 455 gsm fire retardant* PVC coated fabric 5,000 mm, natural white
<b>Inner tent</b>	120 gsm Polycotton, natural white
<b>Ground sheet</b>	190 gsm Polyethylene (HDPE), PVC fabric, sewn in bathtub, light grey/natural white
<b>Windows</b>	<ul style="list-style-type: none"> <li>• 6 Windows on long sidewalls 0.85 x 0.85 m with PE stripes reinforcement</li> <li>• 4 Windows on short sidewalls 0.70 x 0.85 m with PE stripes reinforcement</li> </ul>



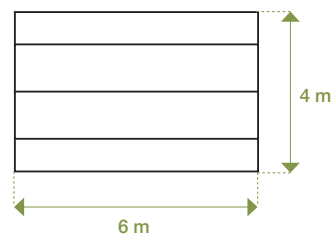
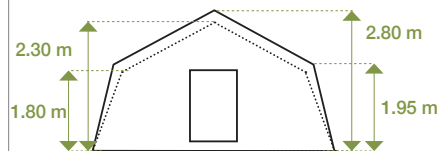

### › Graphic reference



— Outer tent    ..... Inner tent



## Huggy 42

 Fire retardant	 Waterproof	 Rot-proof	 UV stabilized	 All climate zones
--	--	---	---	---



### › Key features

- Waterproof, rot-proof and UV-stabilized
- Lightweight, rectangular and framed tent that can be used for schooling, storage or temporary shelter purposes (comes in three sizes)
- Outer tent fabric is made of 450 - 455 g/m<sup>2</sup> PVC coated fabric, natural white
- Marking and logo customised to your requirements

### › Dimensions

#### Outer tent

<b>Total size</b>	7 x 6 m
<b>Centre height</b>	2.95 m
<b>Wall height</b>	2.10 m

#### Inner tent

<b>Centre height</b>	2.40 m
<b>Wall height</b>	1.95 m

### › Materials

<b>Outer tent</b>	450 - 455 gsm fire retardant* PVC coated fabric 5,000 mm, natural white
<b>Inner tent</b>	120 gsm Polycotton, natural white
<b>Ground sheet</b>	190 gsm Polyethylene (HDPE), PVC fabric, sewn-in bathtub-type, light grey/natural white
<b>Windows</b>	<ul style="list-style-type: none"> <li>• 8 Windows on long sidewalls 0.90 x 1.10 m with PVC stripes reinforcement</li> <li>• 4 Windows on short sidewalls 0.85 x 1.00 m with PVC stripes reinforcement</li> </ul>

### › Graphic reference

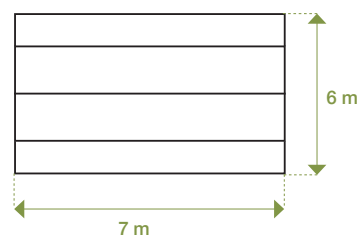
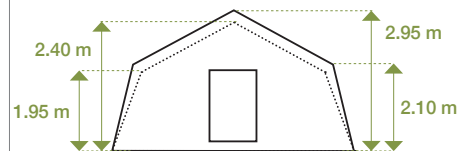

— Outer tent    ..... Inner tent

## Huggy 72

 Fire retardant	 Waterproof	 Rot-proof	 UV stabilized	 All climate zones
--	--	---	---	---



### › Key features

- Waterproof, rot-proof and UV-stabilized
- Lightweight, rectangular and framed tent that can be used for schooling, storage or temporary shelter purposes (comes in three sizes)
- Outer tent fabric is made of 450 - 455 g/m<sup>2</sup> PVC coated fabric, natural white
- Marking and logo customised to your requirements

### › Dimensions

#### Outer tent

<b>Total size</b>	12 x 6 m
<b>Centre height</b>	2.95 m
<b>Wall height</b>	2.10 m

#### Inner tent

<b>Centre height</b>	2.40 m
<b>Wall height</b>	1.95 m

### › Materials

<b>Outer tent</b>	450 - 455 gsm fire retardant* PVC coated fabric 5,000 mm, natural white
<b>Inner tent</b>	120 gsm Polycotton, natural white
<b>Ground sheet</b>	190 gsm Polyethylene (HDPE), PVC fabric, sewn in bathtub, light grey/natural white
<b>Windows</b>	<ul style="list-style-type: none"> <li>• 12 Windows on long sidewalls 1.05 x 1.10 m with PE stripes reinforcement</li> <li>• 4 Windows on short sidewalls 0.85 x 1.00 m with PE stripes reinforcement</li> </ul>

### › Graphic reference

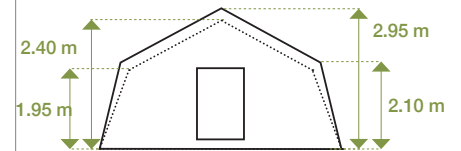

— Outer tent    ..... Inner tent



## Dispensary Tent

ICRC/IFRC Standard

 Waterproof	 Rot-proof	 UV stabilized	 All climate zones
--	---	---	---



### › Key features

- 27.5 sqm waterproof tent ideal for medical, educational, office, storage or accommodation use
- Easy set up with three to four personnel in 30 minutes
- Especially designed for high resistance to wind, rain and micro-organisms
- Has triangular ventilation windows, replaceable logo windows, and cable connectors for power supply
- Optional accessories consist of bath tub ground sheet and shade net, as well as an option for fire retardancy treatment
- Several tents can be assembled in line with the built-in connection strip
- Suitable for 8-20 people

### › Dimensions

<b>Total size</b>	27 m <sup>2</sup>
<b>Length</b>	5.5 m
<b>Width</b>	5.0 m
<b>Wall height</b>	1.8 m

### › Materials

<b>Frame</b>	Aluminium frame, all poles with <ul style="list-style-type: none"> <li>• 40 mm diameter and 2 mm thickness</li> <li>• 8 Standing poles, 175 cm, with base plate,</li> <li>• 8 Ridge beam poles, 145 cm</li> <li>• 9 Ridge poles, 171 cm</li> <li>• 12 Connectors</li> </ul>
<b>Outer tent roof, wall and door</b>	High quality fabric canvas, 440 gsm, waterproof
<b>Shade net</b>	HDPE with 10 metal sticks

### › Graphic reference

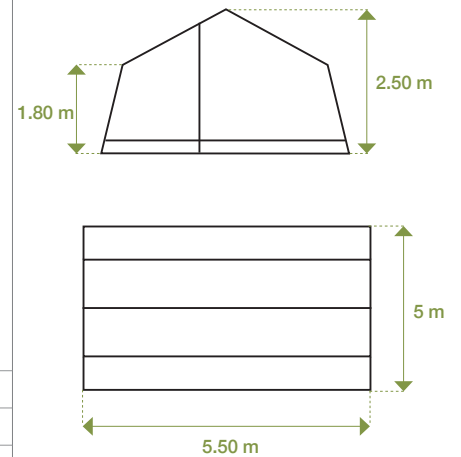

## Inner Liner / Huggy Pro - HPT

UNICEF Standard



Tripple door design



Clean and comfortable



Environmentally friendly



### › Key features

- Designed to create a clean, comfortable, stress-free environment, especially focussing on child-friendly spaces, medical treatment and office/accommodation
- Highly breathable materials with added ventilation grates in gables and along the top of the side walls
- In front of the Inner liner is a small vestibule to be used as storage, changing area or waiting room
- The triple door design allows custom door configurations, with the centre door fitted with an additional mosquito screen door
- The gables in front and back are fitted with inlet ducts for externally placed heating or air conditioning units. In the top left and right corners are inlets for power cables
- Rot and mildew proof, easy to clean and disinfect, resistant to commonly used disinfectants and detergents
- Environmentally friendly: low energy production process, fully recyclable, safely disposable by burning or burying when recycling is not possible

### › Dimensions

<b>Total size</b>	21, 42, 60 m <sup>2</sup>
<b>Floor size</b>	5.8 x 3.5 / 5.8 x 7 / 5.8 x 10 m (±2%)
<b>Central height outer tent</b>	2.60 m (±2%)
<b>Wall height outer tent</b>	2.00 m (±2%)
<b>Structure</b>	Suspended with webbing straps from tent frame
<b>Materials</b>	
<b>Inner liner</b>	<ul style="list-style-type: none"> <li>• 100% Polyester fabric 120-130 g/m<sup>2</sup></li> <li>• Rot-proof   Breathable</li> <li>• Fire resistance: CPAI-84</li> <li>• Colour: Natural White</li> </ul>
<b>Groundsheet</b>	<ul style="list-style-type: none"> <li>• PE 190 g/m<sup>2</sup> approx.   FR CPAI-84</li> <li>• Colour: Light Grey</li> </ul>



### Winter Liner / Huggy Pro - HPT

UNICEF Standard



Insulated flooring



Warm and comfortable



Large windows

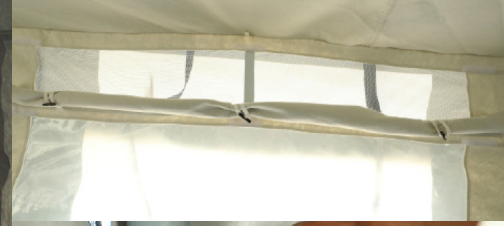

#### › Key features

- Designed to create a warm, comfortable, stress-free environment during winter conditions, especially focussing on child-friendly spaces, medical treatment and office/accommodation
- The insulation flooring tiles add to the comfort. The insulation flooring tiles can be placed on top of the hard flooring tiles in case the underground is too soft
- Highly breathable materials with added ventilation grates in gables and along the top of the side walls
- The winter liner has large windows in the sidewalls to allow daylight in during daytime.
- The right back corner of the winter liner is prepared to place a burning stove for heating. Heat protecting fibrocement tiles, wall panels and chimney sleeve are included
- The gables in front and back are fitted with inlet ducts for externally placed heating or air conditioning units. In the top left and right corners are inlets for power cable

#### › Dimensions

<b>Total size</b>	21, 42, 60 m <sup>2</sup>
<b>Floor size</b>	5.8 x 3.5 / 5.8 x 7 / 5.8 x 10 m (±2%)
<b>Central height outer tent</b>	2.60 m (±2%)
<b>Wall height outer tent</b>	2.00 m (±2%)
<b>Structure</b>	Suspended with webbing straps from tent frame
<b>Materials</b>	
<b>Winter liner</b>	<ul style="list-style-type: none"> <li>• 100% Polyester non-woven felt fabric 300-350 g/m<sup>2</sup></li> <li>• Fire resistance: DIN 4102 B1</li> <li>• Colour: Natural White</li> </ul>
<b>Groundsheet</b>	<ul style="list-style-type: none"> <li>• PE 190 g/m<sup>2</sup> approx.   FR CPAI-84</li> <li>• Colour: Light Grey</li> </ul>
<b>Insulating flooring tiles</b>	PP carpet laminated on 12 mm EVA

The Winter liner kit contains a felt liner, insulated flooring tiles, fibrocement sheet, fire resistant chimney sleeve and wall patches and repair kit

## Hard Flooring / Huggy Pro - HPT

UNICEF Standard



Easy to handle tiles



Non-slip surface



Environmentally friendly

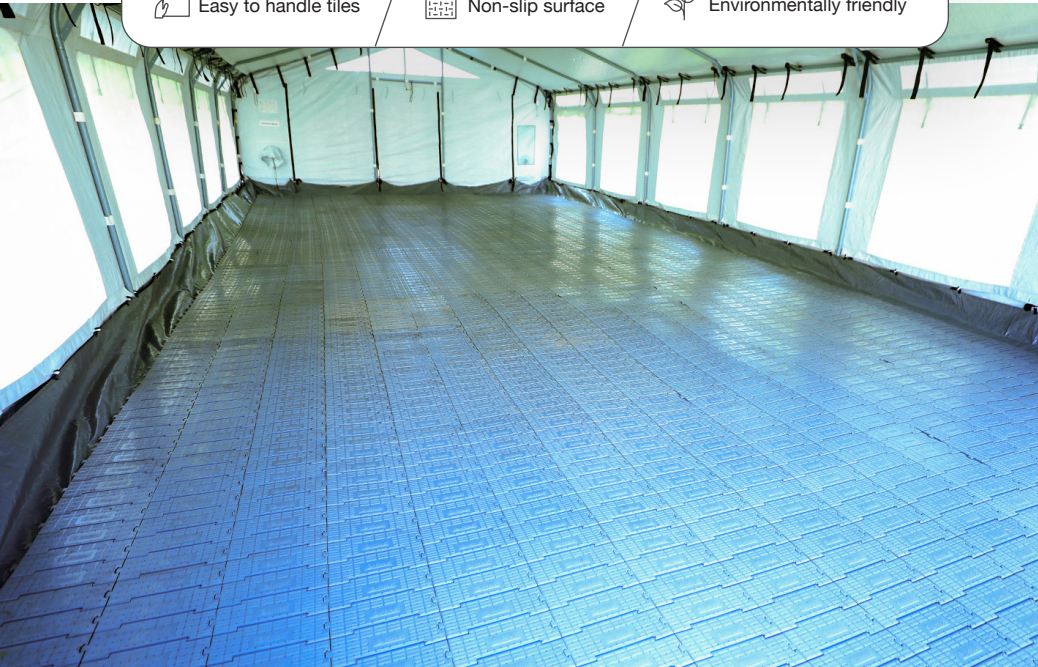

### › Key features

- Modular flooring system for multi-purpose, accommodation, office and warehousing tents
- High load bearing on uneven and soft grounds
- The tiles are pre-assembled to easy-to-handle panels for fast assembly on site
- Non-slip surface
- Penetration holes to allow water pass
- Cable channels enable power cables to pass under the floor
- High visual yellow edge tiles to prevent tripping at entries
- Environmentally friendly: low energy production process, fully recyclable, safely disposable by burning or burying when recycling is not possible

### › Dimensions

<b>Tile size</b>	305 x 102 x 18 mm
<b>Tile per m<sup>2</sup></b>	31.5
<b>Weight m<sup>2</sup></b>	3.84 kg
<b>Load resistance m<sup>2</sup></b>	2,500 kg
<b>Colour</b>	Light grey, bright yellow along the edges
<b>Fire resistance</b>	UL94HB
<b>Packing unit - Master bag with 2 carry-on bags on a wooden pallet</b>	2x 378 tiles / 12 m <sup>2</sup> - total 24 m <sup>2</sup>

### Materials

- Packing**
- PE 190 g/m<sup>2</sup> approx. | FR CPAI-84
  - Colour: Light Grey

100% High impact PolyPropylene



## Solar Lighting Kit / Huggy Pro - HPT

UNICEF Standard



Easy to assemble/disassemble



Tube light dimmer controls



Power saving mode



Logo customizable



### › Key features

- 30/60/90 Wp solar panel configurations
- Directly compatible with UNICEF approved High Performance Tents (24/48/72 m<sup>2</sup>) or similar multi-purpose tents
- Indoor tube lights have separate dimmer controls
- Outdoor tube light with on/off control
- 2A USB charging outlet with current control has a power saving mode that ensures 3 hours of light at low mode
- User-friendly 5 LED indicators for battery life, and low power mode
- Single button to control pilot lamp and battery status
- Built-in pilot lamp for easy location in the dark
- Easily replaceable 12.8V/84Wh
- Expected lifespan is > 3 years, or 1500 cycles (LiFePo4)
- Colours and logos can be customized as per customer requirements

### › Dimensions

<b>Lights</b>	<ul style="list-style-type: none"> <li>• 2x 30 cm tube light 1400 lumens</li> <li>• 1x 15 cm tube light 200 lumens</li> </ul>
<b>Run time</b>	<ul style="list-style-type: none"> <li>• Full charge: 6 hours</li> <li>• Emergency mode: 3 hours @ 10% of max. lumens (*Phone charging will reduce lighting run time)</li> </ul>
<b>Colour characteristics</b>	CRI 80/5000K
<b>Battery lifespan</b>	More than 3 years or 1,500 cycles
<b>Product colour</b>	Customizable to client requirements
<b>Charging</b>	
<b>Solar charging</b>	30 / 60 / 90 WP configurations
<b>Smart phone charging</b>	2x USB ports, USB cable included
<b>Battery</b>	LifePO4 12.8V / 6.6Ah / 84Wh

# Huggy Pro - HPT Add-ons

## Electrical Lighting Kit / Huggy Pro - HPT

UNICEF Standard



Easy to assemble/disassemble



Tube light dimmer controls



Power saving mode



Logo customizable

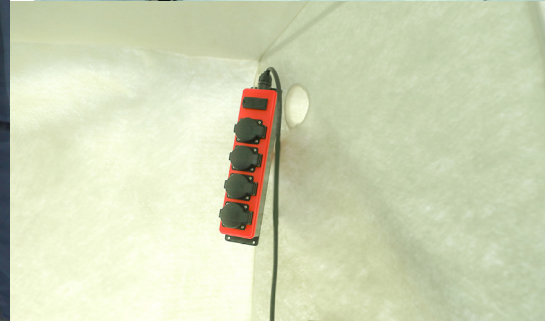
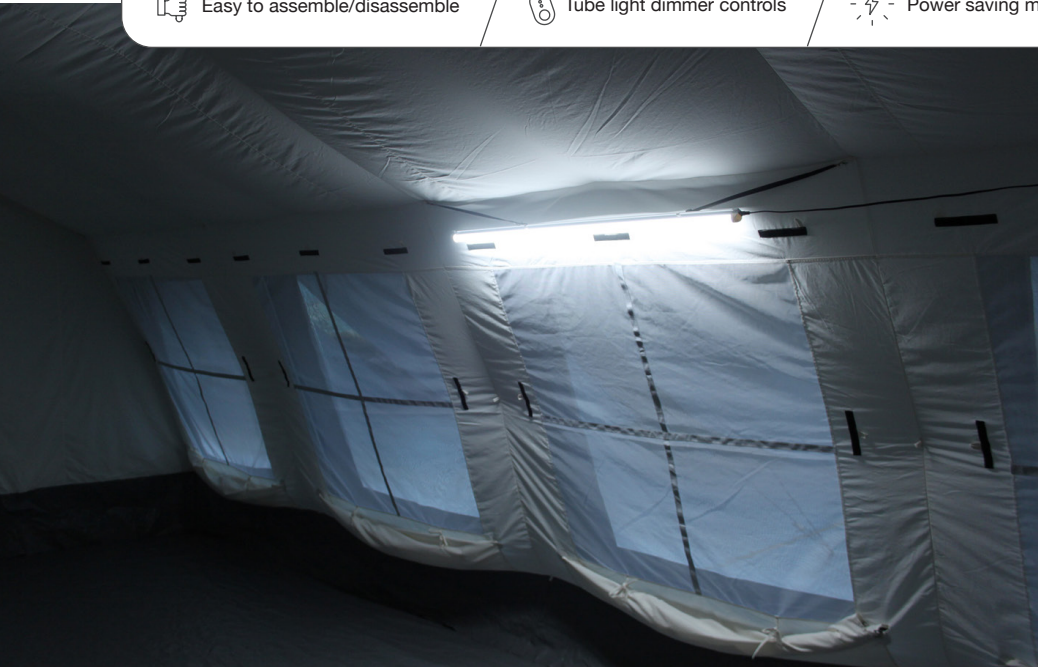

### › Key features

- Designed for High Performance Tents (24/48/72 m<sup>2</sup>), as well as similar type of multipurpose tent
- Durable LED tubes, constructed from aluminium and plexiglass, fitted with adjustable hanging loops
- Scalable system, additional lights and sockets can be added
- Compatible with any shelter with an easy to use unit hanging system
- Indoor tube lights have individual on/off switches
- Outdoor bulb light with on/off control
- 2x 2A USB charging outlet with current control on sockets blocks
- Main power distribution board with 4 outlets with 16A automatic breaker and on/off switch
- Expected lifespan is > 5 years

### › Dimensions

<b>Lights</b>	<ul style="list-style-type: none"> <li>• 3x 100cm LED Tube Light 2400 lumens, IP44</li> <li>• 2x LED Bulb Light 900 lumens, IP44</li> </ul>
<b>Power distribution</b>	<ul style="list-style-type: none"> <li>• Outlet block, 4x sockets, 2x USB, IP44</li> <li>• Distribution board, 4x 16A, IP44</li> </ul>
<b>Plug &amp; Play cabling</b>	Lights connect to sockets block and main distribution board with plugs and sockets
<b>Power requirement</b>	220V / 50Hz
<b>Performance</b>	Min. 350 Lux on 3m distance from light source
<b>Packing</b>	Durable plastic transport box







# Inflatable Tent



Introducing the HuggyAir HPT - an inflatable version of our popular HuggyPro HPT multipurpose tents. This lightweight and spacious tent can be installed in minutes with an electrical air pump, making it perfect for rapid response teams and fast relocation needs. Its modular PVC air frame, lined with TPU airtight tubes, ensures added strength and durability, and any damage can be easily repaired with replacement TPU liner tubes. We offer a variety of add-ons, such as electrical and lighting kits, inner and winter liners, hard flooring, and the newly designed HuggyPro HPT Corridor modules. The HuggyAir HPT comes in a standard width of 6m and is available in 24, 48, and 72 m<sup>2</sup> floor space options. Experience the ease and convenience of the HuggyAir HPT for your next rapid deployment needs.

## HuggyAir - HPT Tent 72 m<sup>2</sup>

 Durable
  Roll-up doors
  Weather proof hood
  Partitioning curtain

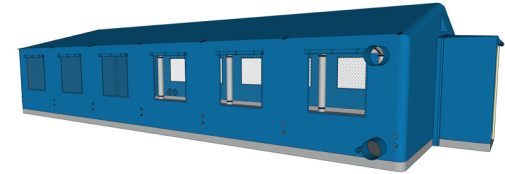
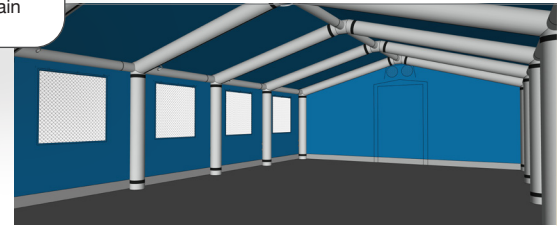
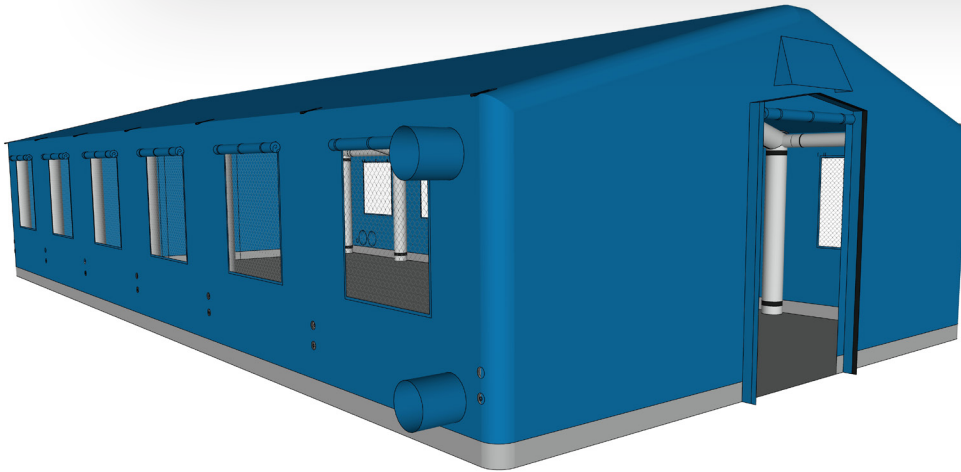

### › Key features

- High performance multipurpose tent with integrated inflatable structure for fast deployment
- Fitted with vertical side walls for optimal use of internal space
- Temporary free-standing shelter solution for medical, operational and accommodation applications

### › Specifications

<b>System</b>	Medium pressure self-erecting inflatable tent
<b>Dimensions</b>	House shape design with vertical walls
<b>Floor area</b>	6.00 x 12.2 m
<b>Side wall height</b>	2.10 m
<b>Centre height</b>	3.10 m
<b>Door</b>	<ul style="list-style-type: none"> <li>• Roll-up door with heavy-duty zipper and fold-down threshold - 120 x 210 cm - 1 in both gables</li> <li>• Prepared for mounting with a Connection Module* or Entry Module*</li> </ul> <p><i>Special configurations with doors in the side walls available on request</i></p>
<b>Windows</b>	3-layer windows - PVC mesh / clear PVC flap / cover fabric flap - 80 x 80 cm - 6 per side wall, 12 in total
<b>Ventilation</b>	PVC mesh ventilation grates in gables with weather proof hood
<b>Ducts</b>	<ul style="list-style-type: none"> <li>• Double ducts in each side wall, 350 mm Ø with closing flap</li> <li>• Cable entry duct in each side wall, 80 mm Ø with closing flap</li> </ul>
<b>Standard features</b>	<ul style="list-style-type: none"> <li>• Fixing points for Partitioning Curtain, Insulation liner* or Ceiling net*</li> <li>• Hanging loops for lights and medical equipment</li> </ul>

### › Graphic reference

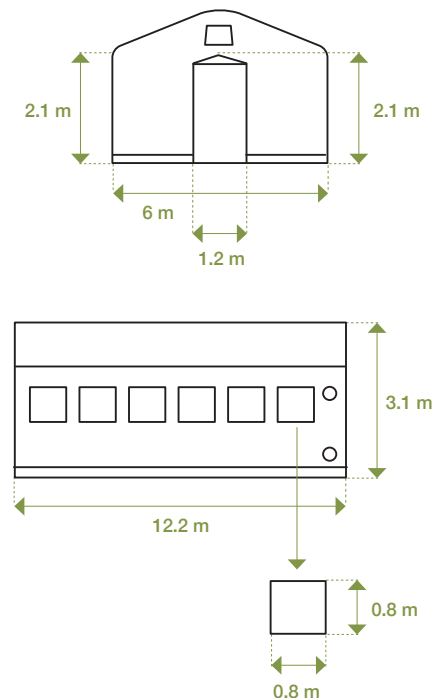



# Mobile Storage Units



Our tent range boasts the unparalleled Rex Hall series mobile storage units (MSU). These units are the epitome of dependability, featuring vast modular spaces that can be used in any weather conditions, and deployed anywhere disaster strikes. The MSUs can be assembled using only people power within a few hours, without the need for mechanical lifting equipment. Their primary use is for storing food, products, and equipment; however, their versatile design enables adaptation to different applications such as hospitals, workshops, offices, or groceries, thanks to a wide range of add-ons, including window and door options, flooring, lighting and electrical supply, and internal partitioning. The Rex Hall units are available in two sizes - 6.5 m and 10 m width - with a minimum length of 8 m. Their length can be extended indefinitely with sections of 4 m. The most commonly used sizes are 6.5 x 8 m, 10 x 24 m, and 10 x 32 m.



## Rex Hall MSU 6.5 x 8 m

WFP Standard

 Fire retardant	 Waterproof	 Rot-proof	 UV stabilized	 Logo customizable
--	--	---	---	---



Packing units with re-useable straps

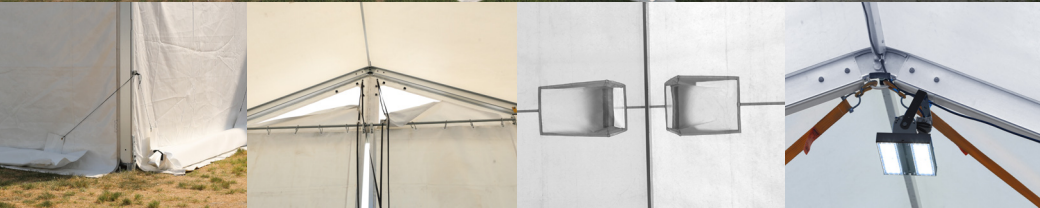

Ballast anchors (to be filled with sand, stones or water)

Gable vents with adjustable cover flaps

Venturi vents in the roof panels

Heavy duty LED Lighting kit

### › Key features

- Standard size 6.5 m width by 8 m length (extra sections of 4 m length can be added) with large entry doors
- Fast setup with four to six people without use of lifting equipment or working on heights
- Made of durable aluminum box profiles and hot-dipped galvanized hardware, with covers of durable fire retardant and UV-resistant translucent PVC fabric and fully high frequency welding for long life
- Designed to withstand high winds up to 0.6 kN/m<sup>2</sup> (<110 km/h) and can be used in both hot and cold climates
- Enhanced ventilation and protection thanks to gable vents with adjustable cover flaps and Venturi vents in the roof panels
- Supplied with ballast anchors and heavy duty LED lighting kit
- MSU can be customized and include optional accessories, such as fire alarm system, lighting system 400 lux, renewable energy, internal partition, solid flooring, pedestrian doors, linking kit, windows and more

### › Dimensions

Standard size	6.5 x 8 m
Total living area	52 m <sup>2</sup>
Main floor	52 m <sup>2</sup>
Centre height	4.0 m
Width	6.50 m
Ridge length	8.00 m
Side wall height	2.50 m

### › Graphic reference

Front view

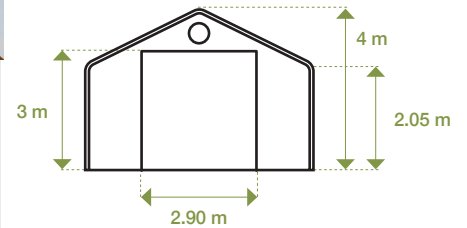

Side view (Windows - Optional)

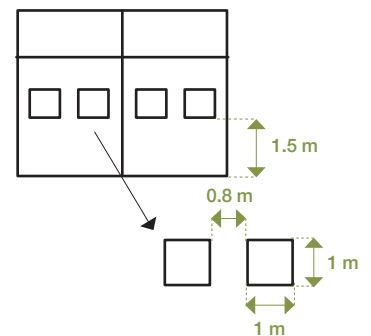



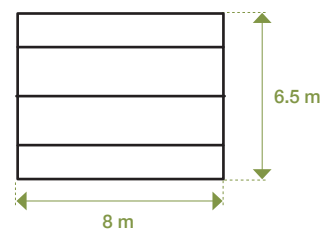

Top view





## Rex Hall MSU 10.0 x 24 m

Used by ICRC/IFRC/WFP/UNICEF/UNHCR

 Fire retardant	 Waterproof	 Rot-proof	 UV stabilized	 Logo customizable
--	--	---	---	---



Packing units with re-useable straps

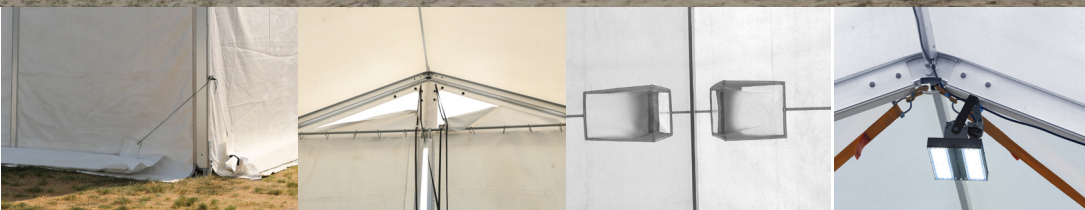

Ballast anchors (to be filled with sand, stones or water)

Gable vents with adjustable cover flaps

Venturi vents in the roof panels

Heavy duty LED Lighting kit

### › Key features

- Standard size 10 m width by 24 m length (extra sections of 4 m length can be added) with large entry doors
- Fast setup with four to six people without use of lifting equipment or working on heights
- Made of durable aluminum box profiles and hot-dipped galvanized hardware, with covers of durable fire retardant and UV-resistant translucent PVC fabric and fully high frequency welding for long life
- Designed to withstand high winds up to 0.6 kN/m<sup>2</sup> (<110 km/h) and can be used in both hot and cold climates
- Enhanced ventilation and protection thanks to gable vents with adjustable cover flaps and Venturi vents in the roof panels
- Supplied with ballast anchors and heavy duty LED lighting kit
- MSU can be customized and include optional accessories, such as fire alarm system, lighting system 400 lux, renewable energy, internal partition, solid flooring, pedestrian doors, linking kit, windows and more

### › Dimensions

Standard size	10 x 24 m
Total useable area	240 m <sup>2</sup>
Main floor	240 m <sup>2</sup>
Centre height	5.50 m
Width	10.00 m
Ridge length	24.0 m
Side wall height	3.30 m

### › Graphic reference

Front view

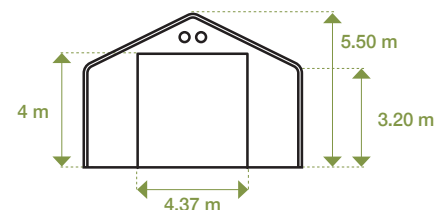

Side view (Windows - Optional)

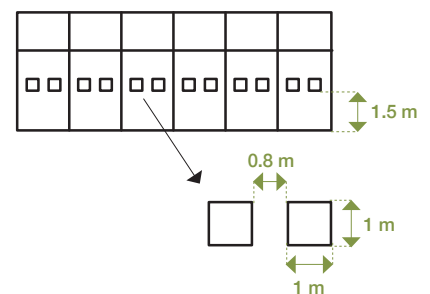

Top view



## Rex Hall MSU 10.0 x 32 m

Used by ICRC/IFRC/WFP/UNICEF/UNHCR

 Fire retardant	 Waterproof	 Rot-proof	 UV stabilized	 Logo customizable
--	--	---	---	---



Packing units with re-useable straps



Ballast anchors (to be filled with sand, stones or water)

Gable vents with adjustable cover flaps

Venturi vents in the roof panels

Heavy duty LED Lighting kit

### › Key features

- Standard size 10 m width by 32 m length (extra sections of 4 m length can be added) with large entry doors
- Fast setup with four to six people without use of lifting equipment or working on heights
- Made of durable aluminium box profiles & hot-dipped galvanised hardware, with covers of durable fire retardant & UV-resistant translucent PVC fabric & fully high frequency welding for long life
- Designed to withstand high wind up to 0.6 kN/m<sup>2</sup> (<110 km/h) & can be used in both hot & cold climates
- Enhanced ventilation and protection thanks to gable vents with adjustable cover flaps and Venturi vents in the roof panels
- Supplied with ballast anchors and heavy duty LED lighting kit
- MSU can be customized and include optional accessories, such as fire alarm system, lighting system 400 lux, renewable energy, internal partition, solid flooring, pedestrian doors, linking kit, windows and more

### › Dimensions

Standard size	10 x 32 m
Total useable area	320 m <sup>2</sup>
Main floor	320 m <sup>2</sup>
Centre height	5.50 m
Width	10.00 m
Ridge length	32.0 m
Side wall height	3.30 m

### › Graphic reference

Front view

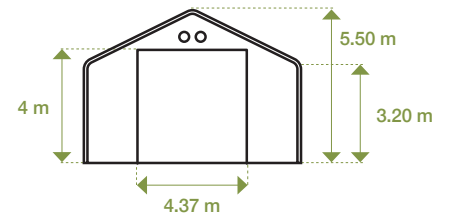

Side view (Windows - Optional)

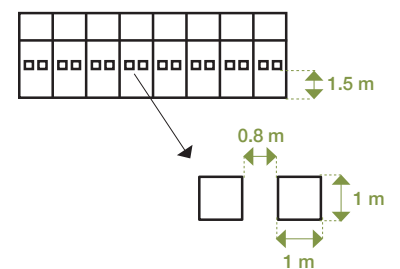

Top view

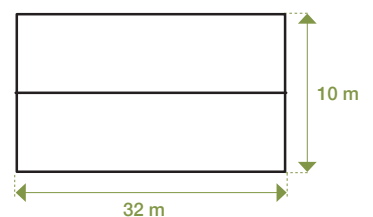



## Rex Hall MSU Add-ons



### › LED Lighting kit, 150 lux or 400 lux

An easy to install, plug & play high performance IP65 LED lighting system is available for Rexhall MSU's. The system contains 60W heavy duty LED lights, including hanging brackets, pre-fitted daisy-chain power cables with 16A CEE plugs and a power distribution box with 4x 16A breakers and CEE sockets, packed in a transport box



### › Ballast Anchors

Ballast Anchor tubes seal the parameters of the structure to prevent the entry of rainwater, dust, sand, or snow. The Ballast Anchors can be filled with water by filling openings at the top or filled with sand or stones through the large opening on one of the ends, sealed with a roll closure. The Ballast Anchors are 3 m in length for the tent gables and 8 m in length to be placed along the side walls



### › Flexible flooring system

PVC-coated polyester fabric panels are used as a waterproof floor covering. This flexible flooring creates a barrier to prevent humidity from seeping underground and entering the tent. It can be placed directly on soil or a concrete foundation platform. Additionally, it serves as a waterproof barrier when placed on top of a solid flooring system

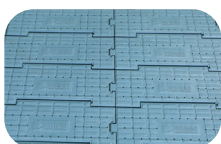

### › Hard flooring system

Easy to assemble flooring tiles to create a stable and flat surface on soft, soggy, and uneven grounds. Designed to create safe and stable flooring, especially when the tents are used for medical applications, accommodation, or office space. Made of high impact polypropylene. Capable of handling loads up to 2500 kg/m<sup>2</sup>



### › Fire Alarm system

A plug & play fire alarm system connects wirelessly with the main fire alarm panel. The optical smoke alarm and heat alarm detectors (with built-in sound alarm), alarm controller, RF relay module and manual call points are powered by long-life lithium batteries, while the main fire alarm panel is powered from the grid while fitted with a back-up battery

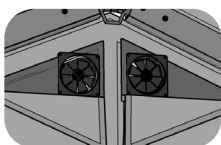

### › Mechanical ventilation

Axial flow extractor ventilators installed in pairs in front of the ventilation grade on one gable side. The electrically operated fans extract the air volume inside the MSU minimum one time per hour. Fresh air enters the MSU via the venturi vents in the roof panels as well as the ventilation grades installed in the opposite gable. The fans operate in all climate conditions



### › Windows

The roof panels can be fitted with mesh windows or transparent windows, with or without cover flaps, in 1, 2 or 3-layer systems



### › Pedestrian doors

The gables and the side walls of the Rexhall can be fitted with fabric roll-up pedestrian doors with heavy-duty zippers or hard aluminium doors in a frame. The doors are pre-manufactured in special gable or bay covers. Each door comes with a special 'no-trip' gable or wall tension bar

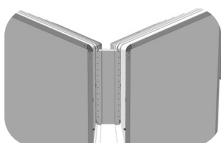

### › Lateral linking kit

When 2 or more MSU's are installed side-by-side, it is possible to create access between the MSU's using a lateral linking kit. The kit consists of roof panels with 3.5 m wide roll up doors in one or both walls as well as a connecting tunnel module to create a weatherproof connection

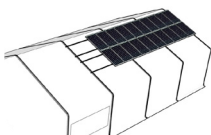

### › Solar energy systems

Turn-key 2.5 kWh or 5 kWh solar power systems, including lithium batteries, 3 kW with built-in MPPT and PV panels with mounting system for safe installation on the MSU roof. Including plug & play cables, fitting and tools

# Core Relief Items



Our range of core relief items is designed to provide immediate relief to the people forced to flee their homes due to natural disasters or conflicts. Our products include tarpaulins, blankets, water containers, sleeping mats, and winterization kits, all of which are essential for alleviating suffering during emergencies. Our aid essentials meet the highest technical standards set by UN agencies and International Aid Organizations, ensuring that they are fit for purpose and can effectively meet the needs of those in need.



## Woven Flexible Tarpaulin

ICRC/IFRC/MSF/IOM Standard



Fire retardant



Waterproof



Rot-proof



UV stabilized



Logo customizable

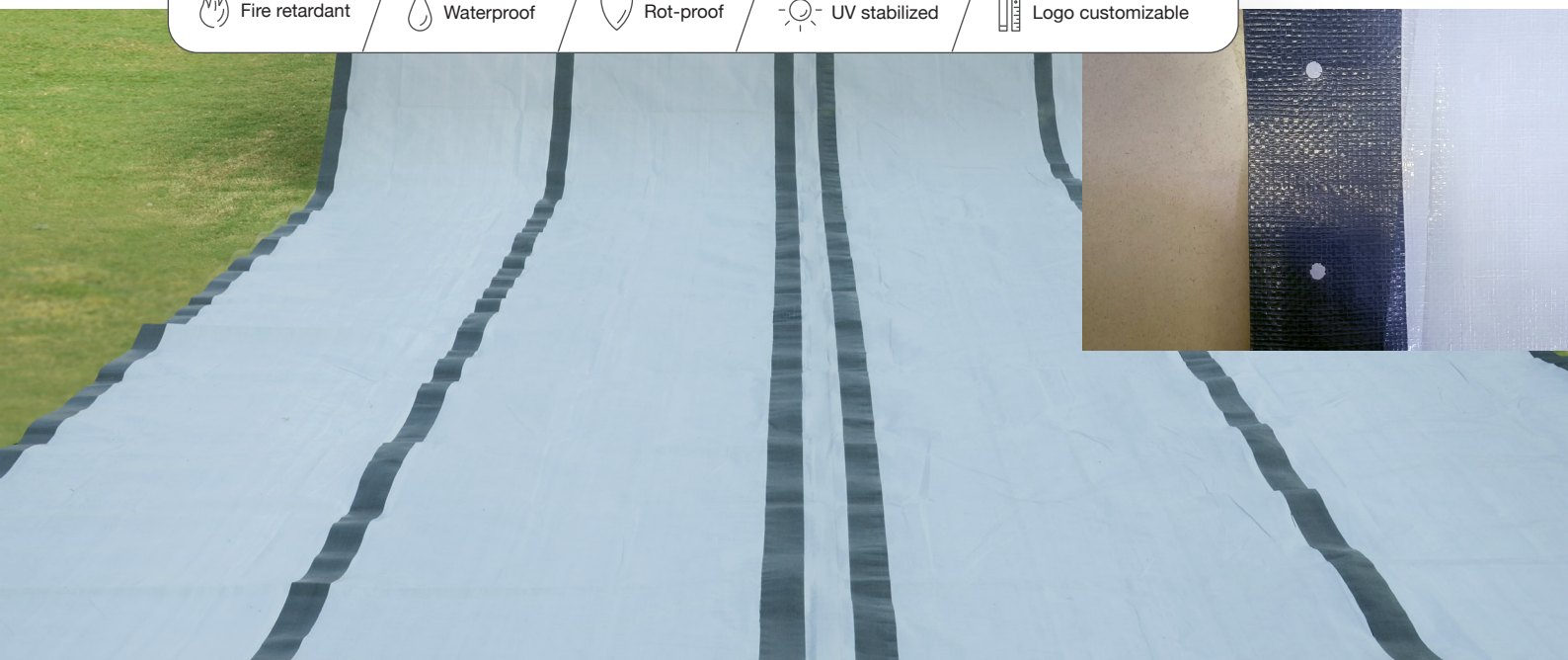

### › Key features

- Fire retardant, waterproof, rotproof and UV-resistant
- Band reinforced tarpaulin in sheet of 4 x 6 m developed by international research project and designed for long outdoor use in all climates
- Woven high density polyethylene (HDPE) black fibres fabric coated on both sides with low density polyethylene (LDPE) coating
- Highly recommended for family shelter protection

### › Dimensions

#### Width and length

**Size / Sheet** 4 x 6 m  $\pm 1\%$ **Size / Roll** 4 x 60 m  $\pm 1\%$ **Specific sheet without bands weight** 190 g  $\pm 20$  under ISO 3801 (equivalent to min 170 to 210 gsm max)**Complete sheet with bands weight** Plain sheet specific weight plus 10% additional weight for reinforcement bands under ISO 3801**Total weight** From min 187 to 231 gsm  
Specific weight of bands from min 150 to 200 gsm max

### › Materials

#### Sheet

- Woven HDPE black fibers fabric, double-side LDPE coating, reinforced with 6 bands of 75  $\pm 3\%$  mm width woven black HDPE fibers fabric and coated outside
- Pre-punched 8 mm holes on the 2 side bands at 0.1 m  $\pm 10\%$  intervals, positioned in the centre of the bands (only the reinforcement bands are pre-punched, not the tarpaulin itself)
- Flame retardant EN13823+A1

**Tensile strength** Min 500N, 15-35% elongation in warp and weft in plain sheet under ISO 1421-1**UV resistance** After 1500 hours, UV under ASTM G53/94 (UVB 313 nm peak) minimum 80% of the original value of the actual product and not less than 475N

### › Graphic reference

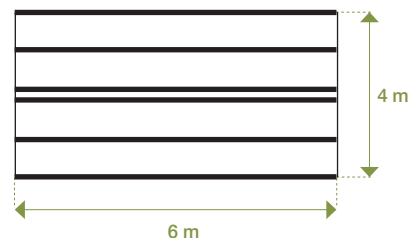

## Reinforced Plastic Tarpaulin

UNHCR/UNICEF Standard



Fire retardant



Waterproof



Rot-proof



UV stabilized



Logo customizable

### › Key features

- Fire retardant, waterproof, rotproof and UV-resistant
- Reinforced plastic tarpaulin in 4 m x 5 m sheet or 4 m x 50 m roll developed by international research project and designed for long outdoor use in all climates
- Made of woven high density black polyethylene (HDPE) fibers, warp x weft, laminated on both sides with lowdensity polyethylene (LDPE) coating
- Highly recommended for family shelter protection

### › Dimensions

#### Width and length

**Size / Sheet** 4 x 5 m  $\pm 1\%$ **Size / Roll** 4 x 50 m  $\pm 1\%$ 

### › Materials





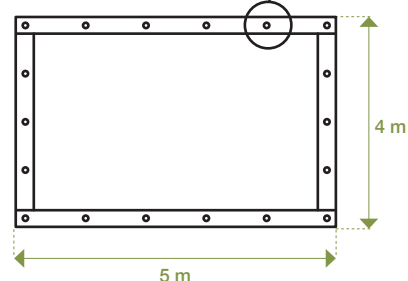

**Sheet / roll** 190 gsm  $\pm 20$  g/m<sup>2</sup> woven Polyethylene (HDPE) inner black fibers, warp x weft, laminated on both sides with LDPE coating**Denier** Min 1,000**Tensile strength** Min 600N both directions warp and weft (BS 2576, 50 mm grab test or equivalent)**Tear strength** Min 100N both directions (BS 4303 wing tear or equivalent) or under ISO 4674 (A2)**UV resistance** Max 5% loss of original tensile strength under ISO 1421 after 1500 hours UV under ASTM G53/94 (UVB 313 nm peak)**Welding** Only one is allowed, lengthwise. Min resistance 80% of original tarpaulin tensile strength in the weft under ISO 1421 plus additional procedure**Eyelets** Aluminum reinforcement eyelets or equivalent on 4 sheet sides of single sheets at 100 cm ( $\pm 5$ ) Centre to Centre, providing very strong fixation points

### › Graphic reference





## Coverage Kit

 Fire retardant
  Waterproof
  Rot-proof
  UV stabilized
  Logo customizable
  Multi-purpose



### › Key features

- Fit-for-purpose shelter kit consisting of two 4 x 6 m plastic sheets, two 24 m long ropes and instructions leaflet
- Designed for those living in humanitarian settlements setup in the aftermath of natural disasters and humanitarian crises
- Durable plastic sheeting made from woven high-density polyethylene (HDPE) black fibres fabric, laminated on both sides with low-density polyethylene (LDPE) coating
- Pre-punched reinforcement bands for easy attachment, such as ropes and nails
- Designed intending to minimise the impact on the environment
- Fire retardant, UV stabilized, water, rot and soil resistant
- Long outdoor use life in all climates
- Fast and easy setup

### › Dimensions

#### Plastic sheeting

<b>Width</b>	4 m ±1%
<b>Length</b>	6 m minimum
<b>Weight</b>	190 g/m <sup>2</sup> ±20 g under ISO 3801 (equivalent to 170 g/m <sup>2</sup> minimum to 210 g/m <sup>2</sup> maximum)

<b>Additional weight of band (10%)</b>	Total weight with Band from 187 g/m <sup>2</sup> minimum and 231 g/m <sup>2</sup> maximum
--	---

#### Rope specifications

<b>Diameter</b>	6 mm
<b>Length</b>	2x 24 m
<b>Weight</b>	320 g
<b>Colour</b>	Black
<b>Packaging</b>	Rope coiled to minimize size and height of overall shelter bale

#### Instructions leaflet specifications

<b>Materials</b>	Printed onto A4 size, Taffeta paper
<b>Content</b>	1-page assembly guide sheet with pictorial instructions

### › Graphic reference

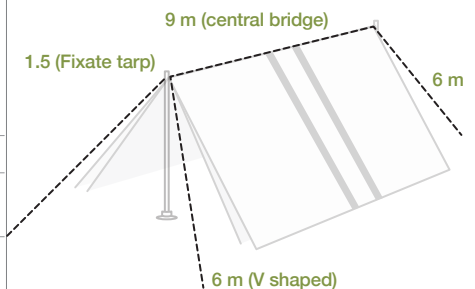
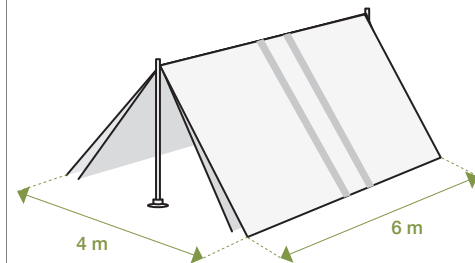

- Cut the ropes into 5 pieces
- Central bridge
  - V-shaped
  - Fixate Tarp

## Viva Stove

ICRC/IFRC Standard



Simple and efficient



### › Key features

- Simple yet efficient wood-burning steel stove and heater design adapted to fit a standard family tent and other type of shelter structures that have appropriate chimney opening
- Works best with our Winterization Kit

#### Includes

- Loading door and air intake control
- Stand, welded to the stove
- Outlet to fit with 100 mm pipes

### › Dimensions

**Master package size** 88 x 30 x 40 cm

**Chimney pipe** 50 cm long

**Chimney outlet** 90 mm

### › Materials

<b>Stove</b>	Steel, 2 mm thick
<b>Chimney outlet</b>	Steel, 90 mm outlet
<b>Chimney pipes</b>	6 pipes made of galvanised steel, anti-rust
<b>Chimney elbows</b>	2 elbows 20° made of steel, anti-rust
<b>Chimney hood</b>	1 hood made of steel, anti-rust
<b>Disc</b>	1 anti-spark disc made of steel
<b>Brackets</b>	2 brackets for holding pipes to the support made of anti-rust iron sheet
<b>Tripod support</b>	Made of square steel tube, minimum 25 x 1 mm thick, anti-rust paint
<b>Weight</b>	Weight of stove without accessories: 16 kg + 1 kg
<b>Colours</b>	Stove and all parts: steel Colour

### › Graphic reference

Chimney pipe

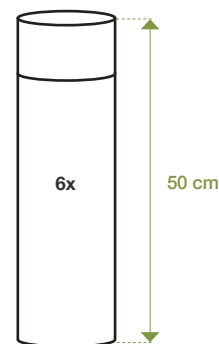



## Aquatainer 10L Collapsible

ICRC/IFRC Standard



With spigot



Safe water storage



Easy to carry



Impact-resistant



### › Key features

- Collapsible 10L water container with handle for carrying and storing clean drinking water
- With spigot
- Impact-resistant
- Can withstand temperatures between -20°C to +50°C
- Manufactured food grade low density polyethylene (LDPE) without toxic elements according to EN 1186-3-9 standards

### › Dimensions

<b>Capacity</b>	10L minimum
<b>Weight</b>	180 g minimum
<b>Inlet interior diameter</b>	30 mm minimum
<b>Built-in handle</b>	90 x 30 mm (LxW) minimum
<b>String</b>	1 mm diameter and 120 mm minimum long

### › Materials

<b>Container</b>	Manufactured food grade LDPE without toxic elements according to EN 1186-3-9 standard
<b>Operating temperature</b>	Can withstand temperatures between -20°C to +50°C
<b>Impact resistance/ drop test</b>	Impact resistant on hard surface when filled with maximum volume of 10L water. Complete drop test consists of 10 consecutive drops from a 2.00 m height. Test result is expressed as a product ranking according to the number of drops passed without damages or leakage. To be accepted, the water container must resist to a minimum of 3 drops
<b>Colour</b>	Translucent

## Aquatainer 10L Collapsible

UNHCR Standard



Safe water storage



Easy to carry



Impact-resistant



### › Key features

- Collapsible 10L water container with handle for carrying and storing clean drinking water
- Without spigot
- Impact-resistant
- Can withstand temperatures between -20°C to +50°C
- Manufactured food grade low density polyethylene (LDPE) without toxic elements according to EN 1186-3-9 standards

### › Dimensions

<b>Capacity</b>	10L minimum
<b>Weight</b>	190 - 230 g
<b>Average thickness</b>	0.60 mm and minimum corner thickness 0.50 mm
<b>Built-in handle</b>	90 x 30 mm (LxW) minimum
<b>String</b>	1 mm diameter and 120 mm minimum long

### › Materials

<b>Container</b>	Manufactured food grade LDPE without toxic elements according to EN 1186-3-9 standard, fitted with built-in carrying handle and removable cap for filling and discharge
<b>Operating temperature</b>	Can withstand temperatures between -20°C to +50°C
<b>Impact resistance/ drop test</b>	Impact resistant on hard surface when filled with maximum volume of 10L water. Complete drop test consists of 10 consecutive drops from a 2.50 m height. Test result is expressed as a product ranking according to the number of drops passed without damages or leakage. To be accepted, the water container must resist to a minimum of 3 drops
<b>Colour</b>	Translucent



## Aquatainer 20L Collapsible

ICRC/IFRC Standard



With spigot



Safe water storage



Easy to carry



Impact-resistant



### › Key features

- Collapsible 20L water container with handle for carrying and storing clean drinking water
- With spigot
- Impact-resistant
- Can withstand temperatures between -20°C to +50°C
- Manufactured food grade low density polyethylene (LDPE) without toxic elements according to EN 1186-3-9 standards

### › Dimensions

<b>Capacity</b>	20L minimum
<b>Weight</b>	270 g minimum
<b>Inlet interior diameter</b>	30 mm minimum
<b>Built-in handle</b>	90 x 30 mm (LxW) diameter minimum
<b>String</b>	1 mm diameter and 120 mm minimum long

### › Materials

<b>Container</b>	Manufactured food grade LDPE without toxic elements according to EN 1186-3-9 standard, fitted with built-in carrying handle and removable cap for filling and discharge
<b>Operating temperature</b>	Can withstand temperatures between -20°C to +50°C
<b>Impact resistance/drop test</b>	Impact resistant on hard surface when filled with maximum volume of 20L water. Needs to complete testing of 10 consecutive drops from a 2.00 m height, filled with water to its normal maximum capacity. To be accepted, the water container must resist to a minimum of 3 drops
<b>Colour</b>	Translucent

## Synthetic Sleeping Mat

UNHCR Standard



Waterproof



Tearproof



Logo customizable

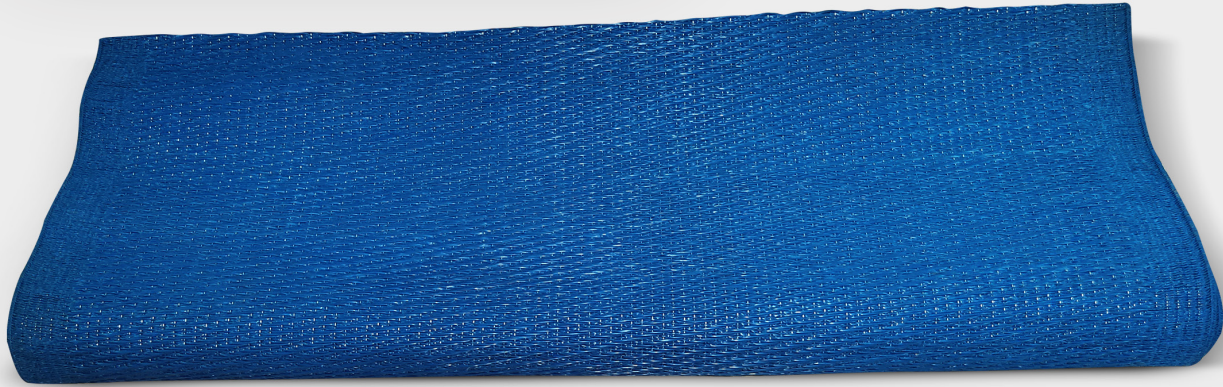

### › Key features

- Waterproof, tearproof and material trim finish
- Will last for +12 months of use under hard tropical conditions
- Suitable for one adult or two children

### › Dimensions

Length x Width	1.80 x 0.90 m
Total weight	500 g/m <sup>2</sup> ±5%

### › Materials

Mat	Warp: thick tape (PP) or polyester yarn Weft: 100% virgin (PP) hollow tubes not containing any filler
End width	Secured with a woven, bias-binding tape with stitches through the mat fabric OR with a double folded stitched hem

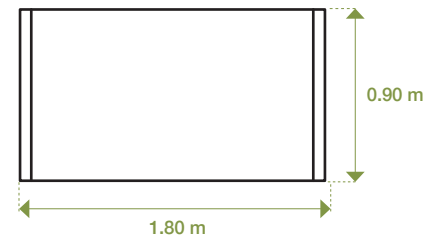

### › Graphic reference





## Multipurpose Sleeping Mat

UNHCR Standard

 Comfortable	 Protection	 Logo customizable
---	--	---

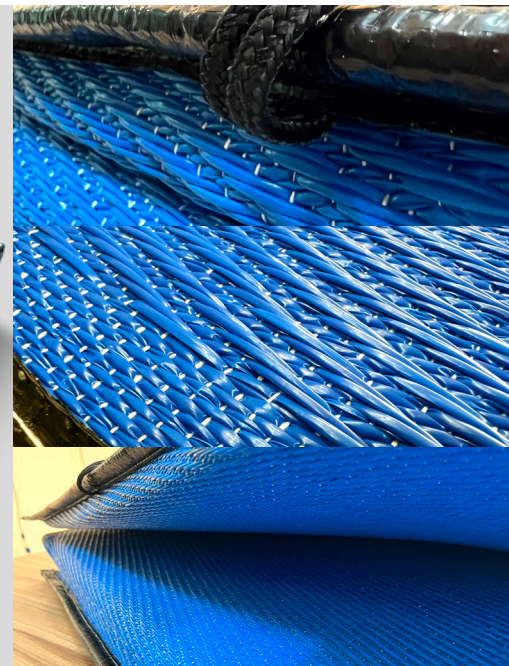

### › Key features

- Foam insulation provides comfort and protection against cold and moisture
- Zig-zag folding makes the mat easy for packing, storage and shipping
- The mat also turns a great seating bench during daytime

### › Dimensions

<b>Mat size</b>	1.8 x 0.9 m ±5%
<b>Mat area</b>	1.62 m <sup>2</sup> ±5%
<b>Weight</b>	0.900 kg/m <sup>2</sup> ±10%
<b>Bursting strength</b>	700 kPa minimum (ISO 13938)
<b>Tear strength</b>	The edges of the mat should not be tear- able when strongly pulled outside by hand or other similar force

### › Materials

- Mat**
- The mats are made from partly recycled polyester yarns and PP straws/tubes. The synthetic yarns and tubes in a tightly woven random structure, using a polyester thread for warping and a min. 500 deniers thick Polypropylene mono-filament straws/ tubes for wefting
  - Sleeping mats are woven in a way to create 4 panels to be filled with 4 pieces of foam (40.5 x 80 x 2 cm ±10%) made of EPE (Expanded Polyethylene) fillers
  - All four sides of the mat are secured with a 5 cm ±10% PE woven bias-binding tape (190 GSM ±10%, UNHCR standard for plastic tarpaulin) with stitches through the fabric of the mat
  - Two 3 mm ±10% ropes each 75 cm ±10% long are fixed on the width side of the mat for binding and folding purposes

- Packing**
- The sleeping mats are packed in bales of five pieces firmly secured with four strong straps

- Pallet details**
- Fumigation as ISPM-15 standard. Maximum height of the packed pallet is 115 cm
  - Pallets are shrink-wrapped and strapped. The palletized goods will not exceed the length and width of the pallet

### › Graphic reference

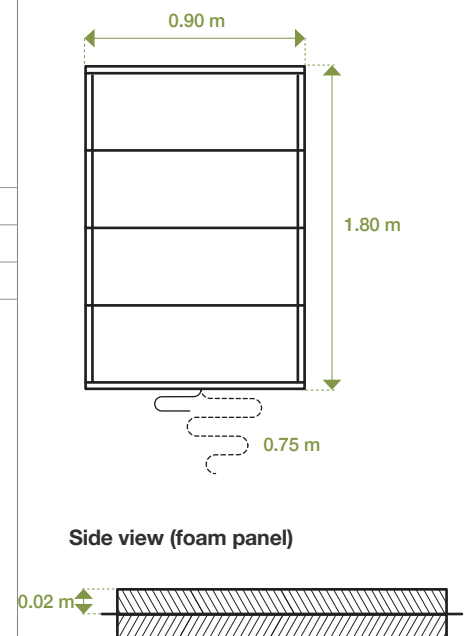

## Viva Thermal Sleeping Mat

ICRC/IFRC Standard

≡ 3-layered ribbon



Logo customizable



### › Key features

- Multi-purpose thermal mat that can be used in tents and in other sleeping environments
- Assembled in 3 layers with heavy-duty ribbon, strongly stitched around the mat's entire perimeter
- Open at one end to allow filling with local materials that will then transform it into an effective mattress
- Can be purchased as part of our Viva Winterization Kit

### › Dimensions

Length x Width	1.80 x 0.90 m
Total weight	3.50 kg

### › Materials

<b>1st layer - Plastic mat</b>	500 gsm virgin poly-propylene (PP) multifilament, 500 denier in warp PP, hollow tube in weft. Fire retardant* to pass CPAI 84/5. Made in tightly woven twill structure, double thickness (2/1, 3/1, 2/2, 3/2), with minimum 1,000 tubes/meter length. With heavy-duty ribbon, strongly stitched around the entire perimeter
<b>1st layer - Aluminized canvas</b>	Strong synthetic canvas with durable aluminum coating, soft and noiseless. Fire retardant* to pass CPAI 84/5. Stitched together, lengthwise in the centre and crosswise in 3 lines, equally spaced
<b>3rd layer - Fleece blanket</b>	Medim thermal blanket. Fire retardant* to pass CPAI 84/5. Stitched together, lengthwise in the centre and crosswise in 3 lines, equally spaced
<b>Mat opening</b>	At one end, the thermal mat is open to allow access in between the plastic mat and aluminized canvas. This opening closes with a fold (as with a pillow closing system)

### › Graphic reference

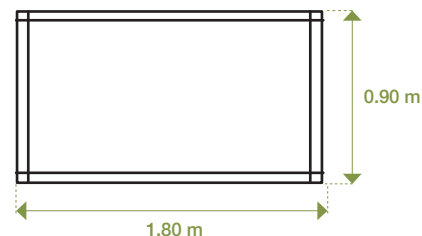



## Pura Water Bucket

ICRC/UNHCR Standard



Safe water storage



Easy to carry



Stackable



With/without spigot



### › Key features

- Non-collapsible, heavy-duty, 14L plastic water bucket with tight-fitting lid, handle and attached clip-on cap
- UV-resistant and safe for transport and storage of safe drinking water
- Stackable and easy to carry by hand, available with or without spigot
- Ideal for family or individual drinking water container

### › Dimensions

Capacity	14L minimum
Top diameter	300 mm $\pm$ 5%
Height	300 mm $\pm$ 5%
Bottom diameter	240 mm $\pm$ 5%

### › Materials

Container	Manufactured of HDPE and LDPE, durable, UV-resistant, safe for water storage
Top	Reinforced to prevent ovaling
Wall	The walls meet the bottom of the bucket with a curved inside surface to prevent dirt accumulation and facilitate cleaning
Lid	The bucket has a tight-fitting lid of the same material as the bucket with an attached push-on cap
Colour	Bucket: White Cover and handle: Red, green or other colour upon request

### › Graphic reference

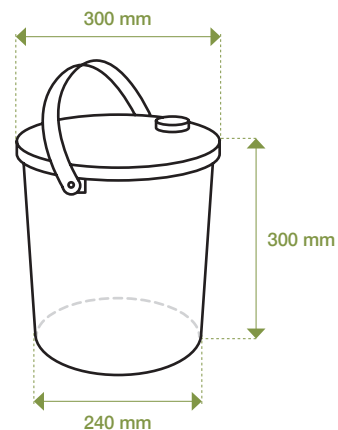

## Pura Jerry Bucket

Oxfam Standard



Safe water storage



Easy to carry



Stackable



With/without spigot



### › Key features

- Improved 14-litre bucket designed to act as a stackable safe water container (rather than as a multipurpose bucket) and to combat the alarming incidence of drinking water contamination
- An HDPE lid is tightly fitted to the body of the bucket through an improved rim lock design
- A larger lid opening with a clip-on-cap allows better cleaning and easier filling from hand pumps
- An optional tap makes taking water from the container simple
- The curved edges at the base prevents dirt and bacteria accumulation
- Made from virgin HDPE high density polyethylene (body of the bucket, lid and cap) and virgin LDPE low density polyethylene (handle)
- Allows easy distribution in large numbers and considerable freight savings
- Strong and durable quality for a long-life span in tough conditions

### › Dimensions

<b>Capacity</b>	14L minimum
<b>Top diameter</b>	300 mm $\pm 5\%$
<b>Height</b>	300 mm $\pm 5\%$
<b>Bottom diameter</b>	240 mm $\pm 5\%$
<b>Component weight</b>	<ul style="list-style-type: none"> <li>• Bucket body: 630 g min.</li> <li>• Lid and cover: 175 g min.</li> <li>• Handle: 30 g min.</li> <li>• Optional tap: 20 g min.</li> </ul>
<b>Gross weight</b>	<ul style="list-style-type: none"> <li>• Bucket, lid, cover &amp; handle: 835 g min.</li> <li>• Bucket with tap, lid, cover &amp; handle: 855 g min.</li> </ul>
<b>Cover with clip on cap diameter</b>	100 mm $\pm 5\%$

### › Materials

<b>Bucket</b>	Made from food grade virgin HDPE high density polyethylene and virgin LDPE low density polyethylene, according to EN1186-3-9. Manufactured by injection molding process
---------------	---

### › Graphic reference

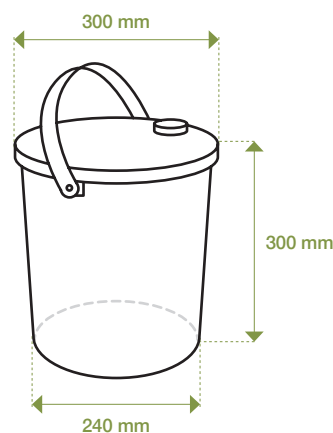



## Low Thermal Synthetic Blanket

ICRC/IOM Standard



Mild temperatures



Logo customizable



### › Key features

- Resistant to fire, thermal & air flow
- Minimum 0.15 Rct (= 1.5 TOG)
- 1.5 x 2 m low synthetic blankets made of virgin fibres from polyester, knitted and dry raised both sides, C.ISO 1833 on dry weight, 100% virgin polyester
- Recommended for indoor use, on a bed, in a house with heating facilities

### › Dimensions

**Total size** 1.50 x 2.00 m (Tolerance -1% +3%)**Weight** 200 - 400 gsm

### › Materials

<b>Blankets</b>	100% virgin fibers from polyester or acrylic, knitted or woven, dry raised both sides, C.ISO 1833 on dry weight, colour grey
<b>Thickness</b>	ISO 5084, 3.5 mm minimum (1KPa on 2000 mm <sup>2</sup> )
<b>Tensile strength</b>	ISO 13934-1: 250N warp and weft minimum
<b>After washing</b>	ISO 13934-1 & ISO 6330: Max 5% warp and weft after 3 consecutive machine washes at 30°C and one flat drying
<b>Shrinkage</b>	ISO 6330: Max 5% warp and weft after 3 consecutive machine washes at 30°C and one flat drying
<b>Weight loss after washing</b>	Max 5% after 3 consecutive machine washes at 30°C and one flat drying
<b>Thermal resistance</b>	ISO 11092: TOG 1.5 (or Rct 0.15 m <sup>2</sup> K/W) minimum, rounded to the nearest 0.01, passed on samples picked from compressed bales. After opening of the bale, the blanket shall be dry tumbled in a dryer for 15 minutes (without any other load), at a temperature of less than 30°C and at least 24 hours by flat lying
<b>Air flow resistance</b>	ISO 9237 under 100Pa pressure drop: Max 1500 L/m <sup>2</sup> /s

### › Graphic reference

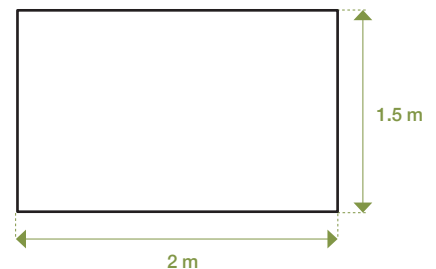

## Medium Thermal Synthetic Blanket

ICRC/IOM Standard



Mild/cold temperatures



Logo customizable



### › Key features

- Resistant to fire, thermal & air flow
- Minimum 0.25 Rct (= 2.5 TOG)
- 1.5 x 2 m medium synthetic blankets made of virgin fibres from polyester, knitted & dry raised both sides, C.ISO 1833 on dry weight, 100% virgin polyester
- Recommended in mildly cold temperatures

### › Dimensions

**Total size** 1.50 x 2.00 m (Tolerance -1% +3%)**Weight** 400 - 700 gsm

### › Materials

<b>Blankets</b>	100% virgin fibers from polyester, knitted & dry raised on both sides, C.ISO 1833 on dry weight, grey
<b>Thickness</b>	ISO 5084, 6.5 mm minimum (1KPa on 2000 mm <sup>2</sup> )
<b>Tensile strength</b>	ISO 13934-1: 250N warp and weft minimum
<b>After washing</b>	ISO 13934-1 & ISO 6330: Max 5% warp and weft after 3 consecutive machine washes at 30°C and one flat drying
<b>Shrinkage</b>	ISO 6330: Max 5% warp and weft after 3 consecutive machine washes at 30°C & one flat drying
<b>Weight loss after washing</b>	Max 5% after 3 consecutive machine washes at 30°C & one flat drying
<b>Thermal resistance</b>	ISO 5085-1: TOG 2.5 (or Rct 0.25 m <sup>2</sup> K/W) minimum, rounded to the nearest 0.1, passed on samples picked from compressed bales after 3 consecutive machine washes at 30°C & one flat drying
<b>Air flow resistance</b>	ISO 9237 under 100Pa pressure drop: Max 1000L/m <sup>2</sup> /s

### › Graphic reference

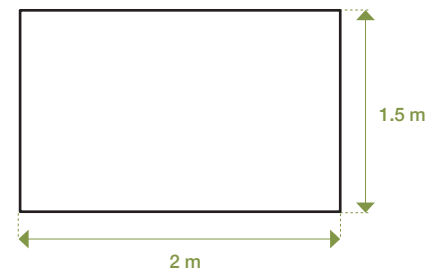



## Medium Thermal Synthetic Blanket

UNHCR/UNICEF Standard



Mild/cold temperatures



Logo customizable



### › Key features

- Resistant to fire, thermal and air flow
- Minimum 2.5 TOG for outdoor use and indoor use without artificial heat
- 1.5 x 2 m medium synthetic blankets made of virgin fibers from polyester, knitted and dry raised both sides, ISO C1833 on dry weight, 100% virgin polyester
- Recommended in mildly cold temperatures

### › Dimensions

**Total size** 1.50 x 2.00 m (Tolerance -1% +3%)**Weight** 400 - 700 gsm

### › Materials

<b>Blankets</b>	100% virgin fibers from polyester, knitted and dry raised on both sides, ISO C1833 on dry weight, grey
<b>Thickness</b>	ISO 5084, 6.5 mm minimum (1KPa on 2000 mm <sup>2</sup> )
<b>Tensile strength</b>	ISO 13934-1: 250N warp and weft minimum
<b>After washing</b>	ISO 13934-1 and ISO 6330: Max 5% warp and weft after 3 consecutive machine washes at 30°C and one flat drying
<b>Shrinkage</b>	ISO 6330: Max 5% warp and weft after 3 consecutive machine washes at 30°C and one flat drying
<b>Weight loss after washing</b>	Max 5% after 3 consecutive machine washes at 30°C and one flat drying
<b>Thermal resistance</b>	ISO 5085-1: TOG 2.5 (or 0.25m <sup>2</sup> K/W) minimum, rounded to the nearest 0.1, passed on samples picked from compressed bales after 3 consecutive machine washes at 30°C and one flat drying
<b>Air flow resistance</b>	ISO 9237 under 100Pa pressure drop: Max 1000L/m <sup>2</sup> /s

### › Graphic reference

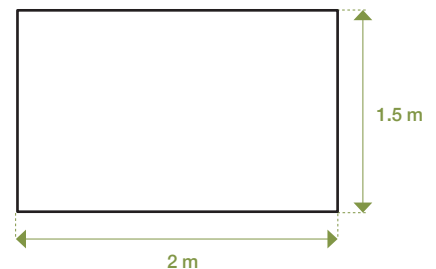

## High Thermal Synthetic Blanket

ICRC/IOM Standard



Cold temperatures



Logo customizable



### › Key features

- Resistant to fire, thermal and air flow
- Min 0.40 Rct (= 4.0 TOG)
- 1.5 x 2 m high synthetic blankets made of virgin fibers from polyester, knitted & dry raised on both sides, C.ISO 1833 on dry weight, 100% virgin polyester
- Recommended for cold climate/temperatures

### › Dimensions

**Total size** 1.50 x 2.00 m (Tolerance -1% +3%)**Weight** 500 - 1000 gsm

### › Materials

<b>Blankets</b>	100% virgin fibers from polyester, knitted & dry raised on both sides, C.ISO 1833 on dry weight, grey
<b>Thickness</b>	ISO 5084, 9.5 mm minimum (1KPa on 2000 mm <sup>2</sup> )
<b>Tensile strength</b>	ISO 13934-1, 250N warp and weft minimum
<b>After washing</b>	ISO 13934-1 & ISO 6330: Max 5% warp and weft after 3 consecutive machine washes at 30°C and one flat drying
<b>Shrinkage</b>	Max ISO 6330: Max 5% warp and weft after 3 consecutive machine washing at 30°C and one flat drying
<b>Weight loss after washing</b>	Max 5% after 3 consecutive machine washing at 30°C and one flat drying
<b>Thermal resistance</b>	ISO 5085-1: TOG 4 (or Rct 0.4 m <sup>2</sup> K/W) minimum, rounded to the nearest 0.1, passed on samples picked from com after 3 consecutive machine washes at 30°C and one flat drying pressed bales
<b>Air flow resistance</b>	ISO 9237 under 100Pa pressure drop: Maximum 1000L/m <sup>2</sup> /s

### › Graphic reference

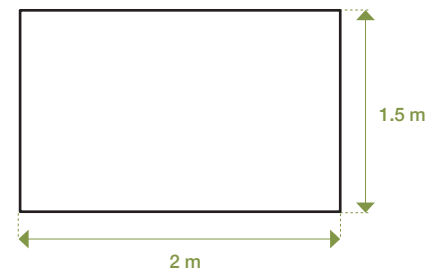



## High Thermal Synthetic Blanket

UNHCR/UNICEF Standard

 Cold temperatures
  Logo customizable



### › Key features

- Resistant to fire, thermal and air flow
- Minimum 4.0 TOG for indoor use and cold climates
- 1.5 x 2 m high synthetic blankets made of virgin fibers from polyester, knitted & dry raised on both sides, ISO 1833 on dry weight, 100% virgin polyester

### › Dimensions

<b>Total size</b>	1.50 x 2.00 m (Tolerance -1% +3%)
<b>Weight</b>	500 - 1000 gsm

### › Materials

<b>Blankets</b>	100% virgin fibers from polyester, knitted & dry raised on both sides, ISO 1833 on dry weight, grey
<b>Thickness</b>	ISO 5084, 9.5 mm minimum (1KPa on 2000 mm <sup>2</sup> )
<b>Tensile strength</b>	ISO 13934-1, 250N warp & weft minimum
<b>After washing</b>	ISO 13934-1 & ISO 6330: Max 5% warp & weft after 3 consecutive machine washes at 30°C and one flat drying
<b>Shrinkage</b>	Max ISO 6330: Max 5% warp & weft after 3 consecutive machine washing at 30°C and one flat drying
<b>Weight loss after washing</b>	Max 5% after 3 consecutive machine washing at 30°C and one flat drying
<b>Thermal resistance</b>	ISO 5085-1: TOG 4 (or 0.4m <sup>2</sup> K/W) minimum, rounded to the nearest 0.1, passed on samples picked from compressed bales after 3 consecutive machine washes at 30°C and one flat drying
<b>Air flow resistance</b>	ISO 9237 under 100Pa pressure drop: Maximum 1000L/m <sup>2</sup> /s

### › Graphic reference

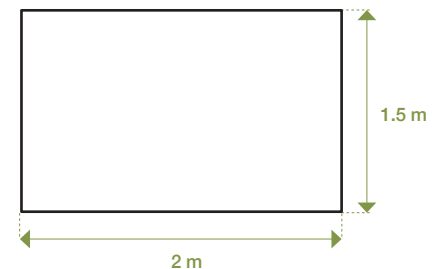

# Non-Standard Items



As a manufacturer of relief items, we understand that every disaster and crisis is unique, and this is why we strive to provide fit-for-purpose solutions to meet the specific needs of our partners. In addition to our standard range of products, we also provide non-standard items that are essential for people's survival and well-being. These include bed linen, hygiene kits, bunk beds, diapers, steel field cots, pillow, sleeping bags, mattress, thermos bottles, towels, and quilts among others.

We believe that these non-standard items can make a significant difference in people's lives, and we will continue to innovate and adapt to ensure that we meet the unique needs of every community we serve.





# Non-Standard Items



Bed Linen



Individual Hygiene Kit /  
Women-Child and Family Kit



Bunk Bed



Adult Diapers



Steel Field Cot



Pillow



Sleeping Bag



Mattress



Thermos



Towel



Quilt



Heater



Visit our website



Follow us on LinkedIn



NRS Relief FZCO  
PO Box 18168  
Jebel Ali Free Zone (JAFZA)  
Dubai, United Arab Emirates

General queries  
[info@nrsrelief.com](mailto:info@nrsrelief.com)

Sales queries  
[bdm@nrsrelief.com](mailto:bdm@nrsrelief.com)